

FLX-3232 Installation and Operation Guide



Important Safety Instructions

- **Please completely read and verify you understand all instructions in this manual before operating this equipment.**
- Keep these instructions in a safe, accessible place for future reference.
- Heed all warnings.
- Follow all instructions.
- Do not use this apparatus near water.
- Clean only with a dry cloth.
- Do not install near any heat sources such as radiators, heat registers, stoves, or other apparatus (including amplifiers) that produce heat.
- Use only accessories specified or recommended by Intelix.
- Explanation of graphical symbols:
 - Lightning bolt/flash symbol: the lightning bolt/flash and arrowhead within an equilateral triangle symbol is intended to alert the user to the presence of uninsulated “dangerous voltage” within the product enclosure which may be of sufficient magnitude to constitute a risk of shock to a person or persons.
 - Exclamation point symbol: the exclamation point within an equilateral triangle symbol is intended to alert the user to the presence of important operating and maintenance (servicing) instructions in the literature accompanying the product.
- **WARNING: TO REDUCE THE RISK OF FIRE OR ELECTRIC SHOCK, DO NOT EXPOSE THIS APPARATUS TO RAIN OR MOISTURE AND OBJECTS FILLED WITH LIQUIDS, SUCH AS VASES, SHOULD NOT BE PLACED ON THIS APPARATUS.**
- Use the mains plug to disconnect the apparatus from the mains.
- **THE MAINS PLUG OF THE POWER CORD MUST REMAIN READILY ACCESSIBLE.**
- Do not defeat the safety purpose polarized or grounding-type plug. A polarized plug has two blades with one wider than the other. A grounding-type plug has two blades and a third grounding prong. The wide blade or the third prong is provided for your safety. If the provided plug does not fit into your outlet, consult an electrician for replacement of your obsolete outlet. **Caution! To reduce the risk of electrical shock, grounding of the center pin of this plug must be maintained.**
- Protect the power cord from being walked on or pinched particularly at the plugs, convenience receptacles, and the point where they exit from the apparatus.
- Do not block the air ventilation openings. Only mount the equipment per Intelix’s instructions.
- Use only with the cart, stand, table, or rack specified by Intelix or sold with the equipment. When/if a cart is used, use caution when moving the cart/equipment combination to avoid injury from tip-over.
- Unplug this apparatus during lightning storms or when unused for long periods of time.
- **Caution! Shock Hazard. Do not open the unit.**
- Refer to qualified service personnel. Servicing is required when the apparatus has been damaged in any way, such as power-supply cord or plug is damaged, liquid has been spilled or objects have fallen into the apparatus, the apparatus has been exposed to rain or moisture, does not operate normally, or has been dropped.



Table of Contents

Overview	6
Package Contents.....	6
Front Panel.....	7
Rear Panel	8
IR Remote.....	8
Input Cards.....	9
Analog Video (FLX-RI4).....	9
DVI (FLX-DI4)	9
HDBaseT (FLX-BI4).....	9
HDMI (FLX-HI4A)	10
Output Cards.....	11
DVI (FLX-DO4)	Error! Bookmark not defined.
HDBaseT (FLX-BO4A).....	Error! Bookmark not defined.
HDMI (FLX-HO4A)	Error! Bookmark not defined.
Long Reach HDBaseT (FLX-BO4A-XL)	Error! Bookmark not defined.
Installation Instructions	11
Shelf Mounting Instructions	13
Rack Mounting Instructions.....	13
General I/O Card Installation	13
FLX-BI4 and FLX-BO4A Wiring.....	14
FLX-RI4 Wiring.....	15
EDID Management.....	17
Copy EDID.....	17
Advanced EDID.....	17
Front Panel and IR Remote Operation.....	18
Basic Routing.....	Error! Bookmark not defined.
Advanced Routing.....	Error! Bookmark not defined.
IR Remote Operation	18
Third Party Control Setup	19
IP Address Setup via Web Browser (Firmware v1.6.4 and below)	19
Access the Web Browser with Defined IP Address (Firmware v1.6.4 and below)	21
Additional Options in Web Browser (Firmware v1.6.4 and below).....	21
IP Address Setup via Web Browser (Firmware v1.6.5 and above)	22

Access the Web Browser with Defined IP Address (Firmware v1.6.5 and above).....	23
Additional Options in Web Browser (Firmware v1.6.5 and above).....	24
RS232 Connection.....	24
RS232 and TCP/IP Commands.....	25
Routing Commands.....	25
Preset Commands.....	26
System Commands.....	26
EDID Commands.....	26
HDCP Commands.....	27
FLX-RI4 Specific Commands (Firmware version 1.6.1 and below).....	27
FLX-RI4 Specific Commands (Firmware version 1.6.4 and above).....	28
FLX-HI4A Specific Commands.....	28
Troubleshooting.....	29
Matrix does not power on.....	29
Cannot view 3D content.....	29
Cannot hear surround sound audio.....	29
No video from HDBaseT input or output.....	29
Technical Specifications.....	30
FLX-3232 Chassis.....	30
FLX-BI4.....	31
FLX-HI4A.....	32
FLX-RI4.....	33
FLX-DI4.....	34
FLX-BO4A.....	35
FLX-HO4A.....	36
FLX-DO4.....	37
FLX-BO4A-XL.....	38
DIGIB-EMT.....	39
DIGIB-EYE.....	39

Overview

The Intelix FLX-3232 is a modular thirty-two input by thirty-two output video matrix switcher. Each modular input or output card supports up to four device connections. In addition to front panel control, the FLX-3232 can be controlled via IR, RS232, or TCP/IP connections.

The modular input cards include the following connections: HDMI (with stereo audio embedding), DVI, HDBaseT (with RS232 and bi-directional wide-band IR), and analog video with digital scaling via HD15 (VGA-UXGA, RGBHV, RGB, RsGsBs, component video, S-video and composite video). The modular output cards include the following connections: HDMI (with stereo audio de-embedding, DVI, and HDBaseT (with audio de-embedding).

Clear button caps provide legible text on the front panel, which can be customized for each installation. IR, RS232, and TCP/IP provide a wide range of options for third party control systems. Ten programmable presets provide an efficient means of configuring the video and audio distribution for common usage patterns.

The FLX-3232 was designed with flexibility in mind. There are over 80 possible input card to output card combinations. Since the system is modular, the system integrator can customize their installation per their customer's needs and not the limitations of available hardware.

Package Contents

Please verify the following items are in the shipping box prior to installation of the FLX-3232.

- 1 ea FLX-3232 Flexible Matrix Switcher
- 2 ea Modular Input Metal Blank (installed on FLX-3232)
- 2 ea Modular Output Metal Blank (installed on FLX-3232)
- 4 ea Rubber Feet
- 1 ea Power Cable
- 1 ea RS232 Cable
- 1 ea Infrared Remote Control
- 1 ea FLX-3232 Installation and Operation Guide
- 1 ea Intelix Pocket Screwdriver

Front Panel

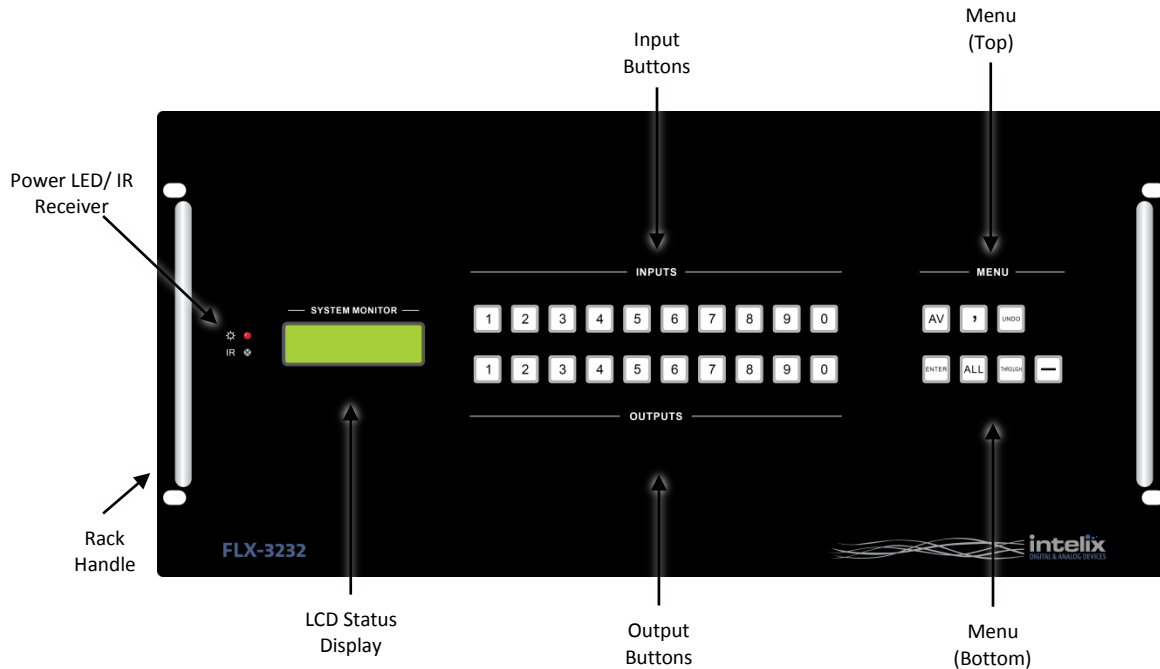

Power LED – Indicates the matrix has proper input power.

IR Receiver – For use with the included IR remote.

Input Buttons –Buttons labeled “1” through “10”.

Menu Buttons (Top Row) –Buttons labeled “AV”, “COMMA”, and “UNDO”.

AV – Used to route Video and Audio inputs to outputs

COMMA – Used to separate output selections when routing an input to multiple outputs

UNDO – Recalls the previous route.

Rack Handle – Eases installation in an equipment rack.

LCD Status Display – Displays matrix name and status when changing routes.

Output Buttons –Buttons labeled “1” through “10”.

Menu Buttons (Bottom Row) –Buttons labeled “ALL”, “THROUGH”, “UNDO”, and “←”.

ENTER – Used to execute the currently entered routing.

ALL – Used to route one input AV pair to all outputs or to route each AV input to its corresponding output.

THROUGH – Used to route the selected AV input to its corresponding output.

← – Used to clear the input source select.

Explanation of use for the front panel control is located in the section *Front Panel Operation* (page 18).

Rear Panel

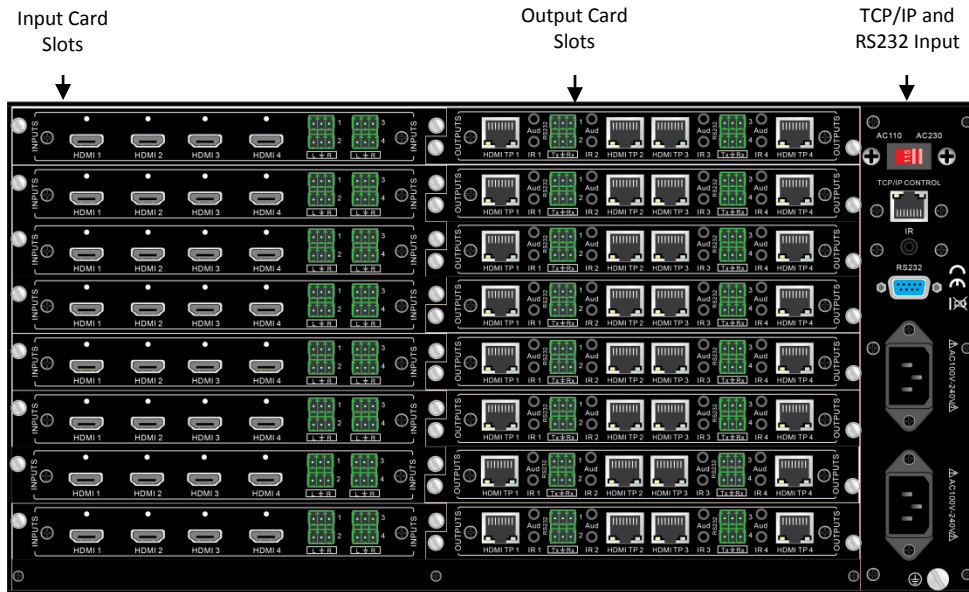

110-240 VAC
Input

Input Card Slots – Eight card slots to accommodate compatible input cards.

Output Card Slots – Eight card slots to accommodate compatible output cards.

TCP/IP Input – Allows control via third party control system and web browser access.

RS232 Input – Allows control via third party control system.

AC Input – Standard IEC C14 inlet. Redundant power inlet – connect to [2] separate circuits, if the first circuit loses power, the matrix will switch automatically to the other circuit.

IR Remote

The included IR remote performs all of the functions available on the front panel of the FLX-3232.



Input Cards

The modular input cards are keyed on the right side to line up with the output cards and ensure they are installed correctly in the matrix.

Analog Video (FLX-RI4)

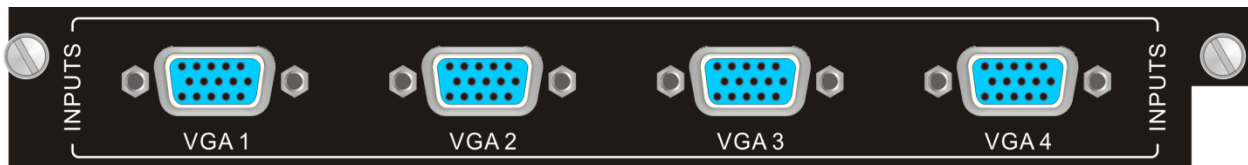

The HD15 inputs on the FLX-RI4 scale and convert a wide range of analog video signals to HD video resolutions, which can be routed to any available output. The individual scaler engine on each input can accommodate VGA to UXGA, RGBHV, RGB, RsGsBs, component video, S-video, and composite video signals. Two FLX-RBOCA (component video breakout cable) and two FLX-RBOCB (composite and S-video breakout cable) cables are included with each FLX-RI4. See page 27 for commands to specify the input signal type.

DVI (FLX-DI4)

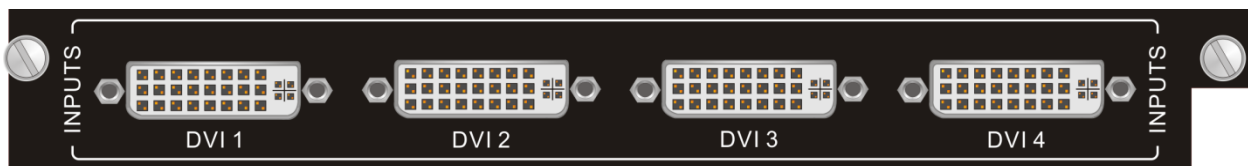

The FLX-DI4 DVI-D inputs are HDMI and HDCP compliant and support CEC and DDC standards. Each input is a single link DVI-D connection that can support video resolutions up to 1920x1200.

HDBaseT (FLX-BI4)

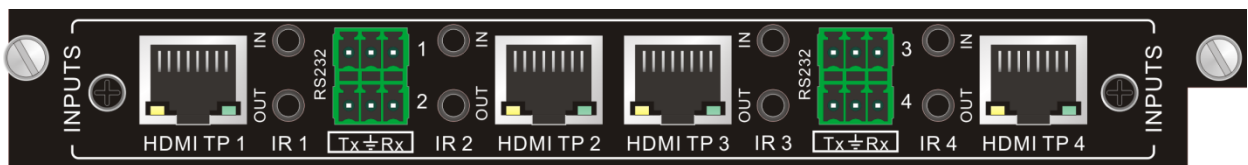

The FLX-BI4 takes advantage of HDBaseT inputs to allow sources from remote locations, from up to 70 m away, to be routed to any of the available outputs utilizing standard Cat 5e cable with a TIA-568B crimp. The RS232 and wide-band IR connections for each input allow bi-directional control signals at the equipment rack to interface with source equipment when used with the DIGI-HD70C-S or DIGI-HDE-S HDBaseT transmitters. The optional DIGIB-EMT (IR emitter) and DIGIB-EYE (IR receiver) are required for IR control functionality.

HDMI (FLX-HI4A)

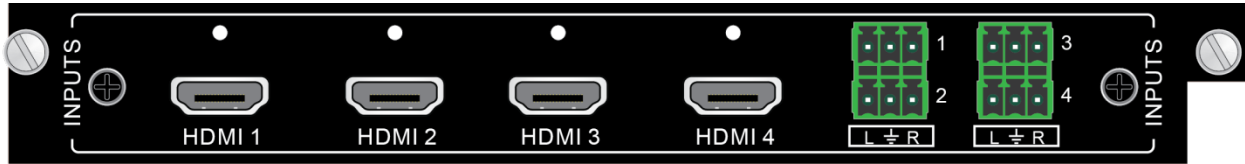

The FLX-HI4A HDMI inputs can be routed to any available outputs. The HDMI inputs can accept video signals up to 1920x1200, including 3D and 48-bit Deep Color at 1080p. Additionally, audio signals from stereo up to 7.1 audio streams will pass through the matrix to supported outputs. The input audio source is selectable (HDMI or analog) by RS232 or TCP/IP commands.

If the analog audio input is to be used in the installation, connect the Left, Right, and Ground reference wires to the removable 3-pole terminal block.

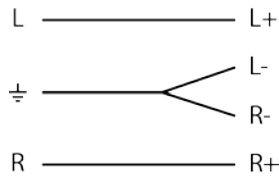

Output Cards

The modular output cards are keyed on the left side to line up with the input cards and ensure they are installed correctly in the matrix.

DVI (FLX-DO4)

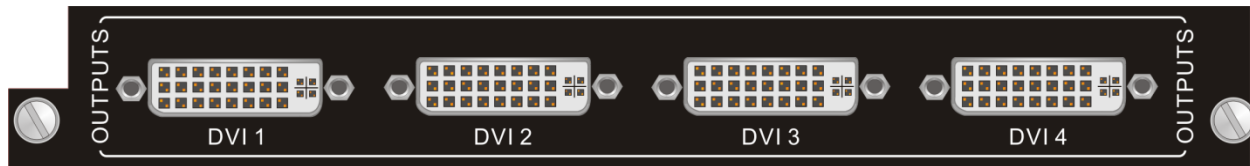

The FLX-DO4 DVI-D outputs are HDMI and HDCP compliant and support CEC and DDC standards. Each output is a single link DVI-D connection that can support video resolutions up to 1920x1200.

HDBaseT (FLX-BO4A)

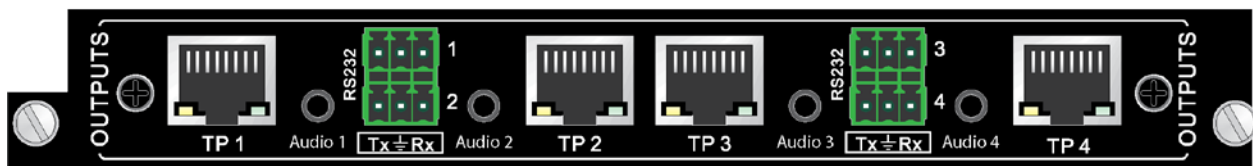

The FLX-BO4 takes advantage of HDBaseT outputs connect any source device to a remote display, up to 70m away, utilizing standard Cat 6 cable with a TIA-568B crimp. The RS232 connections for each output allow bi-directional control signals at the equipment rack to interface with display devices when used with the DIGI-HD60C-R or DIGI-HDE-R HDBaseT receivers. Stereo audio can be de-embedded from the HDMI signal and output to the 3.5mm TRS connectors. This unit has advanced EDID copy functions that allow either full or hybrid copy (video with 2ch overwrite) to ensure that the source will emit the correct format.

HDMI (FLX-HO4A)

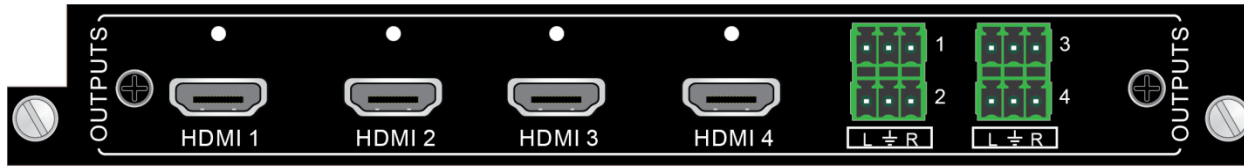

The FLX-HO4 HDMI outputs can be routed from any input in the matrix. The HDMI outputs can pass video signals up to 1920x1200, including 3D and 48-bit Deep Color at 1080p. Additionally, audio signals from stereo up to 7.1 audio streams will pass to supported HDMI output devices. This unit has advanced EDID copy functions that allow either full or hybrid copy (video with 2ch overwrite) to ensure that the source will emit the correct format (see page 17).

If the analog audio output is to be used in the installation, connect the Left, Right, and Ground reference wires to the removable 3-pole terminal block.

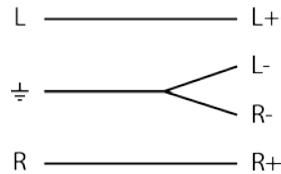

Long Reach HDBaseT (FLX-BO4A-XL)

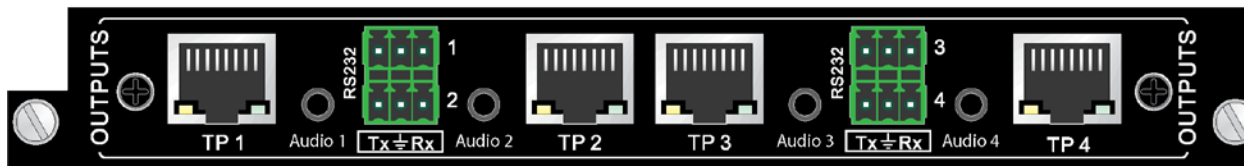

The FLX-BO4A-XL takes advantage of HDBaseT outputs connect any source device to a remote display, up to 150m away, utilizing shielded Cat 5e or greater cable. The bi-directional RS232 connections for each output allow control signals at the equipment rack to control displays connected to compatible receivers. The FLX-BO4A-XL also includes the ability to extract stereo audio from the HDMI signal. The stereo analog audio is output to 3.5mm jacks. The FLX-BO4A-XL features advanced EDID handling features that ensure video and audio compatibility, such as full copy and hybrid copy functions.

The DIGI-HDXL series extenders are only compatible with Intelix XL-series HDBaseT product offerings. An HDBaseT link will not be established with other HDBaseT products.

Installation Instructions

Shelf Mounting Instructions

Attach the supplied rubber feet to the bottom of the FLX-3232 matrix. Follow the instructions in *General I/O Card Installation* to install the I/O cards.

Rack Mounting Instructions

The FLX-3232 requires three rack units (5 RU) of space. At least 2 inches of free air space is required on both sides of the FLX-3232 for proper side ventilation. Avoid mounting the FLX-3232 near a power amplifier or any other source of significant heat. It is recommended that you leave an empty rack space above and below the FLX-3232 for additional cooling.

General I/O Card Installation

1. Power off the matrix.
2. Remove the metal blank.



- Slide the I/O card between the guide rails until it is firmly seated.

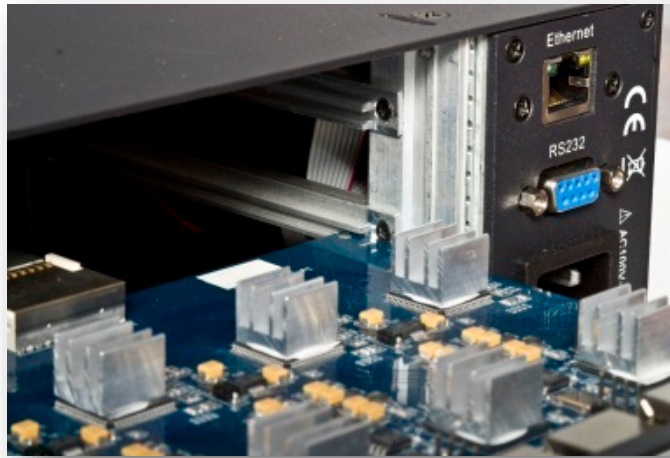

- Secure the I/O card by tightening the thumb screws.



- Connect the appropriate cabling to the I/O card.
- Power on the matrix.

FLX-BI4 and FLX-BO4A Wiring

A compatible HDBaseT with control transmitter or receiver is required to pass the control signals to the source or display devices.

To connect the FLX-BI4 to a compatible transmitter or the FLX-BO4A to a compatible receiver, a Cat 6 or greater cable with a TIA-568B crimp termination on the RJ45 connector must be used. The Cat 6 cable must not exceed 40 meters for 3D content. The Cat 6 cable must not exceed 70 meters for 2D content.

To use the IR extension capabilities of the FLX-BI4, the DIGIB-EYE (wideband IR receiver) and DIGIB-EMT (wideband IR emitter) will need to be connected to the appropriate IR ports. These parts are not included with the HDBaseT I/O cards.

To use the RS232 extension capabilities of the FLX-BI4 and FLX-BO4A, connect the TX, ground, and RX control signal wires to the removable 3-pole terminal block. Consult the manual of the control device(s) to determine which pins the TX/RX signals are carried on. Be sure to always connect TX to RX and RX to TX.

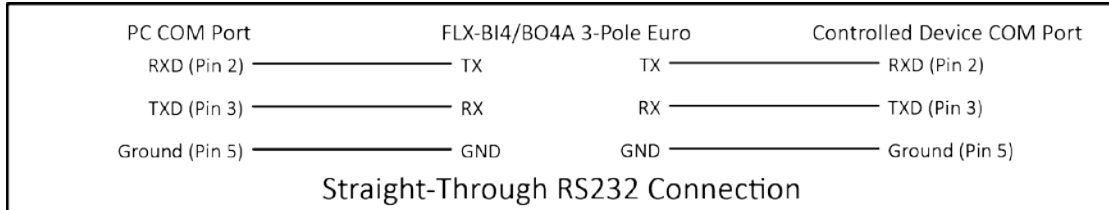

FLX-RI4 Wiring

For VGA signals, use a standard VGA male to VGA male cable.

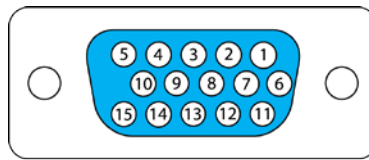

VGA PORT ON FLX-RI4

For RGBHV signals, use a standard VGA to RGBHV cable. Below is a common pinout of this type of cable.

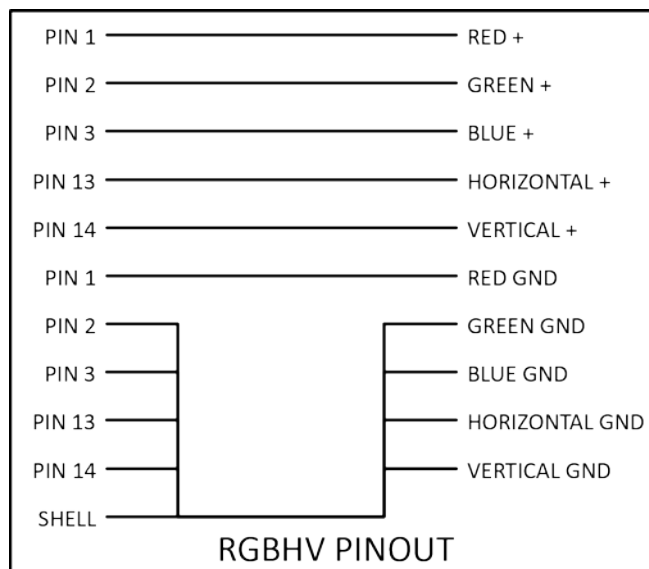

For component video, S-video, and composite video, a VGA to breakout cable is recommended. The FLX-RI4 comes with two FLX-RBOCA (component video breakout cable) and two FLX-RBOCB (composite and S-video breakout cable) cables. See *FLX-RI4 Specific Commands* on page 27 to define the operation of the inputs.

- Component video, RGSB, and RsGsBs connect to the appropriate red, green, and blue connections on the FLX-RBOCA cable.



- S-video connects to the purple connector on the FLX-RBOCB cable.
- Composite video connects to the yellow connector on the FLX-RBOCB cable.

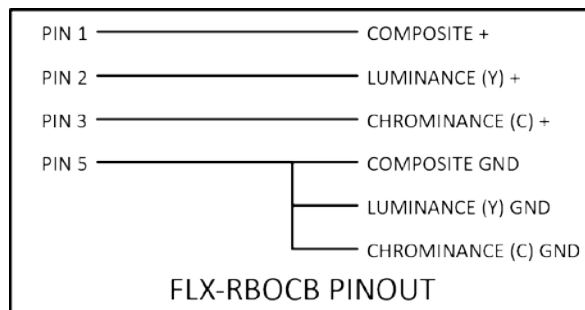

EDID Management

The stock EDID for the inputs of the FLX-3232 is 1280x1024 (computer video input) and 1080p with stereo audio (consumer video input). In order to change the EDID information for an input, the EDID copy command will need to be sent to the matrix via RS232 or TCP/IP.

EDIDMyyBxx.	Copy EDID of output yy to input xx
EDIDMInit.	Restore factory EDID information

The FLX-RI4 input card ignores the EDID settings since there is a scaler engine on each input to output a pre-defined video resolution.

Copy EDID

To copy the EDID information from output 3 to input 1, transmit the following command:

```
EDIDM03B01.
```

Advanced EDID

The FLX-HO4A and FLX-BO4A support [2] EDID Copy modes; FULL copy and HYBRID copy. The copy mode can be set by output. On each card, you will find [4] DIP switches near the back of the PCBA (card must be removed from matrix). Each DIP switch corresponds to an output of the card. Set the DIP switches ON for FULL copy mode. Set the DIP switches OFF for HYBRID copy mode.

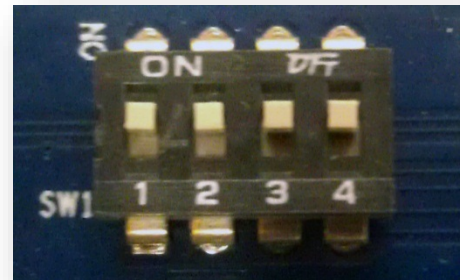

When the output is set to FULL copy mode, the entire EDID table will be copied from the display (sink) to the input. This accomplished via RS232 or TCP/IP command.

When the output is set to HYBRID, the EDID table that is copied to the input comes from two locations. The video information, including Preferred Native Timing is retrieved from the display (sink) that is connected to the output. The audio information is overwritten by a 48kHz PCM stereo audio preset. Copying EDID with this HYBRID mode will ensure that all your sources output a format that is compatible with the audio de-embedding circuit.

Front Panel and IR Remote Operation

Basic Routing

To set a route using the front panel of the FLX-1616:

1. Press the desired input button (source).
2. Press the AV button.
3. Press the desired output button (display).
4. Press the ENTER button

To route video and audio from input 4 to output 5:

1. Press input 4.
2. Press AV.
3. Press output 5.
4. Press ENTER

Advanced Routing

To route an input to multiple outputs:

1. Press the desired input.
2. Press AV.
3. Press the desired outputs, separated by the COMMA button.
4. Press ENTER.
(Example: i2 AV o4 , o5 , o6 , ENTER)

To route video and audio from input 3 to all outputs:

1. Press input 3.
2. Press ALL.

To route video and audio from each input to its corresponding output (1 to 1, 2 to 2, through 8 to 8):

1. Press ALL.
2. Press THROUGH.

IR Remote Operation

The buttons on the IR remote are similar to the buttons on the front panel of the FLX-3232. The IR routing commands match those of the front panel, except multiple output routing is not possible.

See Page 8 for the button layout of the IR remote.

Third Party Control Setup

IP Address Setup via Web Browser (Firmware v1.6.4 and below)

Configuring the TCP/IP port is done via a web browser interface. A crossover cable is required for the initial setup. The default IP address is printed on a sticker on the side of the FLX-3232.

1. Configure the computer to use the same network prefix as the IP address assigned to the matrix. For example, the IP address of the matrix is 192.168.0.178. Set the computer to use a static IP address within the same network range, such as 192.168.0.42.
2. Connect the crossover cable to the computer and to the TCP/IP port on the FLX-3232.
3. Open up Internet Explorer (Firefox, Chrome, and Safari crop the configuration options).

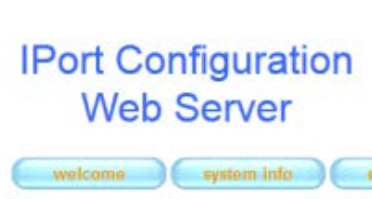
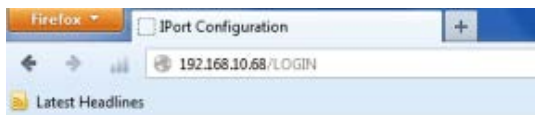

Welcome to IPort Web Server!

Welcome to IPort Web Server!

4. Go to the IP address printed on the sticker, which will take you to the Login screen.

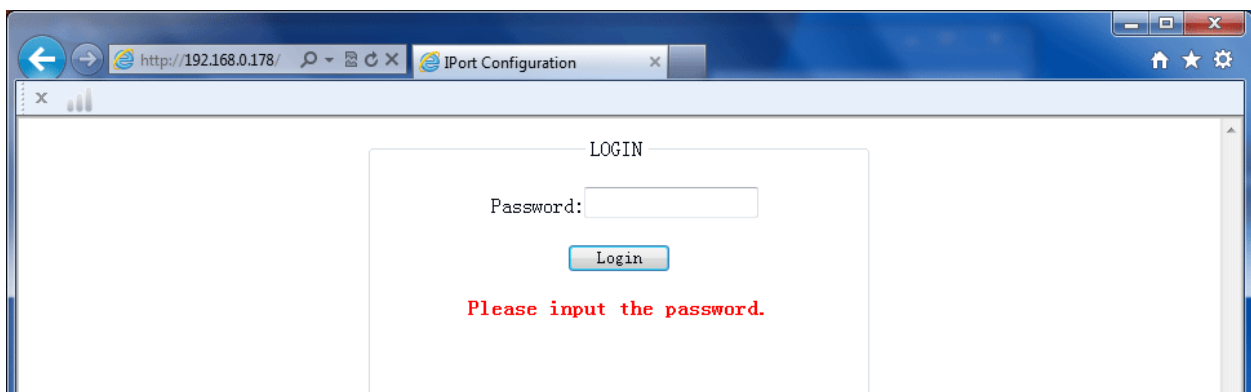

5. The Default password is "88888".

- Press the LOGIN button. **Pressing the Enter key will give a bad password error.**
- Click the System Info button to change the IP address.

IPort Configuration Web Server

welcome system info serial info change password reset device restore default

Network Parameters

Device Name: IPort IP Mode: Static

IP: 192 168 0 178 Gateway: 192 168 0 1

SubMark: 255 255 255 0 DNS Server: 192 168 0 1

Device Parameters

Command Port: 3003 Web Port: 80

IP Filter

Filter1: IP SubMark

Filter2: IP SubMark

Filter3: IP SubMark

Filter4: IP SubMark

Filter5: IP SubMark

Filter6: IP SubMark

Filter7: IP SubMark

Filter8: IP SubMark

Apply Reset Value

- Changing the dropdown option from Static to DHCP will allow the FLX-3232 to automatically obtain an IP address from a DHCP server on the network.
- For a static IP, enter the IP address, Gateway, and DNS Server information provided by your Network Administrator.
- Click Apply for the changes to take effect.

Access the Web Browser with Defined IP Address (Firmware v1.6.4 and below)

1. Remove the crossover cable between the computer and the FLX-3232.
2. Restore the computer to the previous network settings.
3. Connect the computer and the matrix to the network.
4. Using Internet Explorer, enter the IP address for the matrix to access the browser interface.

Additional Options in Web Browser (Firmware v1.6.4 and below)

1. Serial Info – Adjusts TCP/IP specific settings, including the default port (4001).
 - a. Changing the baud rate settings has no effect on the RS232 port of the FLX-3232.
 - b. The baud rate setting must remain at 9600.
2. Change Password – Changes the password of the matrix.
3. Reset Device – Resets all changes to the default settings except for the IP address of the matrix.
4. Restore Default – Resets all changes to the default settings including the IP address.

IP Address Setup via Web Browser (Firmware v1.6.5 and above)

Configuring the TCP/IP port is done via a web browser interface. A crossover cable is required for the initial setup. The default IP address is printed on a sticker on the side of the FLX-3232.

1. Configure the computer to use the same network prefix as the IP address assigned to the matrix. For example, the IP address of the matrix is 192.168.0.178. Set the computer to use a static IP address within the same network range, such as 192.168.0.42.
2. Connect the crossover cable to the computer and to the TCP/IP port on the FLX-3232.
3. Open up any internet web browser.
4. Go to the IP address printed on the sticker directed to port 100, which will take you to the Login screen (192.168.0.178:100).

5. The default User Name is *admin* and the default Password is *admin*.
6. Press the *Log In* button.
7. Expand the *Internet Settings* folder and click *WAN*.

- Changing the *WAN Connection Type* dropdown option from Static to DHCP will allow the FLX-3232 to automatically obtain an IP address from a DHCP server on the network.

goahead
WEB SERVER™

m) i) m) o) bility™

[open all](#) | [close all](#)

web-server
Internet Settings
WAN
Administration
Upload Program

Wide Area Network (WAN) Settings

You may choose different connection type suitable for your environment. Besides, you may also configure parameters according to the selected connection type.

WAN Connection Type:

Static Mode	
IP Address	<input type="text" value="192.168.0.178"/>
Subnet Mask	<input type="text" value="255.255.255.0"/>
Default Gateway	<input type="text" value="192.168.0.1"/>
Primary DNS Server	<input type="text" value="8.8.8.8"/>
Secondary DNS Server	<input type="text" value="8.8.8.8"/>
MAC Clone	
Enabled	<input type="text" value="Enable"/>
MAC Address	<input type="text" value="44:33:4C:C9:5A:7F"/> <input type="button" value="Fill my MAC"/>

- For a static IP, enter the IP address, Gateway, and DNS Server information provided by your Network Administrator. Adjusting values for MAC Clone will revert to the original MAC address.
- Click Apply for the changes to take effect.

Access the Web Browser with Defined IP Address (Firmware v1.6.5 and above)

- Remove the crossover cable between the computer and the FLX-3232.
- Restore the computer to the previous network settings.
- Connect the computer and the matrix to the network.
- Using a web browser, enter the IP address for the matrix directed to port 100 to access the browser interface.

Additional Options in Web Browser (Firmware v1.6.5 and above)

1. *web-server: Status* – Displays system up time and matrix network settings in *Internet Configurations* table.
2. *web-server: Statistic* – Displays network communication statistics.
3. *web-server: Management* – Allows changing of Administrator account name (default is *admin*) and password (default is *admin*). Other settings have no effect on matrix operation as of firmware version 1.6.5.
4. *Administration: Upload Program* – Page to upload future firmware updates to the matrix.

RS232 Connection

The RS232 control port requires a standard straight-through serial cable for operation. The default settings for the RS232 port are:

- 9600 baud
- 8 Data Bits
- 1 Stop Bit
- Parity = none

RS232 and TCP/IP Commands

RS232 Settings: 9600 baud, 8 Data bits, 1 Stop bit, Parity = None

TCP/IP Settings: User defined IP address, port 4001

There is either a period (.) or a semicolon (;) at the end of each command. These characters must be present for the command to process correctly.

There are no spaces between any of the characters in the command string.

xx = Input Number (input 2 would be 02)

yy = Output Number (output 3 would be 03)

<CR> = Carriage return (Hex 0D)

<LF> = Line Feed (Hex 0A)

Routing Commands

Description	Command	Response
Route input <i>xx</i> to output <i>yy</i>	<i>xxByy.</i>	AV: <i>xx</i> ->0 <i>yy</i> <CR><LF>
Route input <i>xx</i> to all outputs	<i>xxAll.</i>	<i>xx</i> To All<CR><LF>
Route inputs to corresponding outputs	All#.	All Through.<CR><LF>
Route input <i>xx</i> to multiple outputs <i>yy</i> Number of outputs is unlimited; each output must be separated by a comma (,)	<i>xxByy,yy.</i>	<i>xxVyy,yy</i> <CR><LF>
Turn off all outputs	All\$.	All Closed.<CR><LF>
Turn off specific output <i>yy</i>	<i>yy\$.</i>	AV: <i>yy</i> Closed.<CR><LF>
Output <i>yy</i> routing status	Status <i>yy.</i>	V: <i>xx</i> ->0 <i>yy</i> <CR><LF>
Routing status of all inputs.	Status.	V: <i>xx</i> ->0 <i>yy</i> <CR><LF> (Repeating sequence starting with output 1, output 2, etc.)

Examples:

02All.	Route Video and Audio from input 2 to all outputs
04\$.	Turn off Video and Audio for output 4
06B03.	Route Video and Audio from input 6 to output 3
03B02,08.	Route Video and Audio from input 3 to outputs 2 and 8

Preset Commands

Description	Command	Response
Save the current routing as a preset. Values range from 0 through 9	Savex.	Save to Fx<CR><LF>
Recall preset x	Recallx.	Recall From Fx<CR><LF>
Clear preset x	Clearx.	

Examples:

Save4.	Save the current routing as preset 4.
Recall4.	Recall preset 4
Clear4.	Clear preset 4

System Commands

Description	Command	Response
Power full ON	PWON.	PWON<CR><LF>
Power off (Standby Mode)	PWOFF.	PWOFF<CR><LF>
Retrieve matrix model information	/*Type;	FLX-3232<CR><LF>
Lock the front panel keys	/%Lock;	System Locked!<CR><LF>
Unlock the front panel keys	/%Unlock;	System Unlock!<CR><LF>
Retrieve matrix firmware version number	^Version;	Vz.z<CR><LF>
Turn off matrix command feedback	/:MessageOff;	Closed the Message Return.<CR><LF>
Turn on matrix command feedback	/:MessageOn;	Enabled the Message Return.<CR><LF>

EDID Commands

Description	Command	Response
Copy EDID of output yy to input xx	EDIDMyyBxx.	EDIDMyyBxx.<CR><LF>
Restore factory EDID information	EDIDMInit.	EDIDMInit<CR><LF>

Example:

EDIDM05B01.	Copy EDID of output 5 to input 1
-------------	----------------------------------

HDCP Commands

Description	Command	Response
Turn HDCP Compliance off for input xx	/%I/xx:0.	/%I/xx:0.<CR><LF>
Turn HDCP Compliance on for input xx	/%I/xx:1.	/%I/xx:1.<CR><LF>

Example:

/%I/04:0.	Turn HDCP Compliance off for input 4
-----------	--------------------------------------

FLX-RI4 Specific Commands (Firmware version 1.6.1 and below)

The input number values are dependent upon which slot the FLX-RI4 is inserted. If the input card is in the first input card slot, the input number values range from 01 through 04. If the input card is in the second input card slot, the input number values range from 05 through 08. xx is the input number value.

Description	Command	Response
Set input xx to VGA input mode	PTN/I/xx:0622%;	xx:0622%.<CR><LF>
When input xx is in VGA mode, auto adjusts the input signal	PTN/I/xx:0606%;	xx:0606%.<CR><LF>
Set input xx to component video input mode	PTN/I/xx:0623%;	xx:0623%.<CR><LF>
Set input xx to S-video input mode	PTN/I/xx:0624%;	xx:0624%.<CR><LF>
Set input xx to composite video input mode	PTN/I/xx:0625%;	xx:0625%.<CR><LF>
Set input xx to scale to XGA output (1024x768)	PTN/I/xx:0626%;	xx:0626%.<CR><LF>
Set input xx to scale to 720p output (1280x720)	PTN/I/xx:0627%;	xx:0627%.<CR><LF>
Set input xx to scale to WXGA output (1280x800)	PTN/I/xx:0628%;	xx:0628%.<CR><LF>
Set input xx to scale to 1080p output (1920x1080)	PTN/I/xx:0629%;	xx:0629%.<CR><LF>
Set input xx to VGA input mode	PTN/I/xx:0622%;	xx:0622%.<CR><LF>

Examples:

PTN/I/05:0622%;	Set input 5 to VGA input mode
PTN/I/05:0606%;	Auto adjust input 5 VGA source
PTN/I/02:0623%;	Set input 2 to component video input mode

FLX-RI4 Specific Commands (Firmware version 1.6.4 and above)

The input number values are dependent upon which slot the FLX-RI4 is inserted. If the input card is in the first input card slot, the input number values range from 01 through 04. If the input card is in the second input card slot, the input number values range from 05 through 08. *xx* is the input number value.

Description	Command	Response
Set input <i>xx</i> to VGA input mode	USER/I/ <i>xx</i> :0622%;	<i>xx</i> :0622%.<CR><LF>
When input <i>xx</i> is in VGA mode, auto adjusts the input signal	USER/I/ <i>xx</i> :0606%;	<i>xx</i> :0606%.<CR><LF>
Set input <i>xx</i> to component video input mode	USER/I/ <i>xx</i> :0623%;	<i>xx</i> :0623%.<CR><LF>
Set input <i>xx</i> to S-video input mode	USER/I/ <i>xx</i> :0624%;	<i>xx</i> :0624%.<CR><LF>
Set input <i>xx</i> to composite video input mode	USER/I/ <i>xx</i> :0625%;	<i>xx</i> :0625%.<CR><LF>
Set input <i>xx</i> to scale to XGA output (1024x768)	USER/I/ <i>xx</i> :0626%;	<i>xx</i> :0626%.<CR><LF>
Set input <i>xx</i> to scale to 720p output (1280x720)	USER/I/ <i>xx</i> :0627%;	<i>xx</i> :0627%.<CR><LF>
Set input <i>xx</i> to scale to WXGA output (1280x800)	USER/I/ <i>xx</i> :0628%;	<i>xx</i> :0628%.<CR><LF>
Set input <i>xx</i> to scale to 1080p output (1920x1080)	USER/I/ <i>xx</i> :0629%;	<i>xx</i> :0629%.<CR><LF>
Set input <i>xx</i> to VGA input mode	USER/I/ <i>xx</i> :0622%;	<i>xx</i> :0622%.<CR><LF>

Examples:

USER/I/05:0622%;	Set input 5 to VGA input mode
USER/I/05:0606%;	Auto adjust input 5 VGA source
USER/I/02:0623%;	Set input 2 to component video input mode

FLX-HI4A Specific Commands

The input number values are dependent upon which slot the FLX-HI4A is inserted. If the input card is in the first input card slot, the input number values range from 1 through 4. If the input card is in the second input card slot, the input number values range from 5 through 8. *[X]* is the input number value.

Description	Command	Response
Set input <i>xx</i> to analog audio input embedding	AUDIO <i>xx</i> :0.	AUDIO <i>xx</i> I0.<CR><LF>
Set input <i>xx</i> to digital audio (use HDMI audio)	AUDIO <i>xx</i> :1.	AUDIO <i>xx</i> I1.<CR><LF>

Examples:

AUDIO07:0.	Use analog audio for input 7.
------------	-------------------------------

Troubleshooting

Matrix does not power on

Verify power outlet is active.
Verify continuity in power cable.

Cannot view 3D content

Copy EDID from output to input.
Verify display is 3D compatible.
Verify source device can output 3D content.
Verify twisted pair cable does not exceed 40 meters if using the FLX-BI4 or FLX-BO4.

Cannot hear surround sound audio

Copy EDID from output to input.
Verify output can broadcast surround sound audio.
Verify source device is configured to output surround sound audio.
Change input from analog audio to HDMI audio (FLX-HI4A)

No video from HDBaseT input or output

Verify the green link LED on the HDBaseT card is lit solid.



Technical Specifications

FLX-3232 Chassis

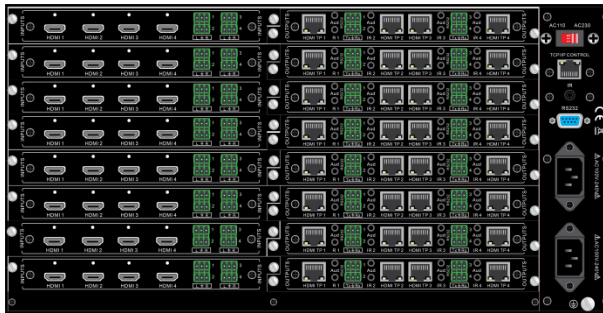
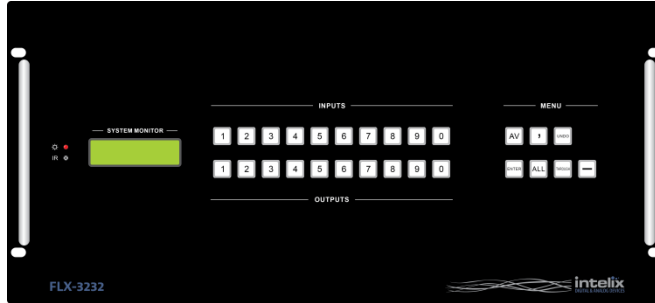

Technical Specifications	
I/O Connections	
Supported Input Cards	FLX-BI4, FLX-DI4, FLX-HI4, FLX-RI4, FLX-HI4A
Supported Output Cards	FLX-BO4, FLX-DO4, FLX-HO4, FLX-BO4A, FLX-HO4A
Input and Output Card Securing Mechanism	Thumbscrew
Control, Rear Panel	RS232 via DE-9, TCP/IP via 8P8C Connector
Control, Front Panel	Push Button, IR
Chassis and Environmental	
Material	Black Painted Aluminum
Dimensions	483mm x 356mm x 222mm (19 in. x 14 in. x 8.75 in.)
Rack Spacing	5 RU
Shipping Weight	9.98 kg (22 lbs.)
Operating Temperature	0° to +40° C (+32° to +104° F)
Operating Humidity	20% to 90%, Non-condensing
Storage Temperature	-10° to +60° C (+14° to +140° F)
Storage Humidity	20% to 90%, Non-condensing
Power, ESD, and Regulatory	
Power Supply	100-240VAC 50/60 Hz
Power Consumption	280 watts Fully Populated
ESD Protection	15kV
Regulatory	CE, RoHS
Other	
Warranty	2 years
Diagnostic Indicators	LCD output status and power LED
Included Accessories	Installation Guide, IR Remote, RS232 Cable, Power Cable, Modular Metal Blank (16 ea), Rubber Feet (4 ea) and Intelix Pocket Screwdriver.

FLX-B14

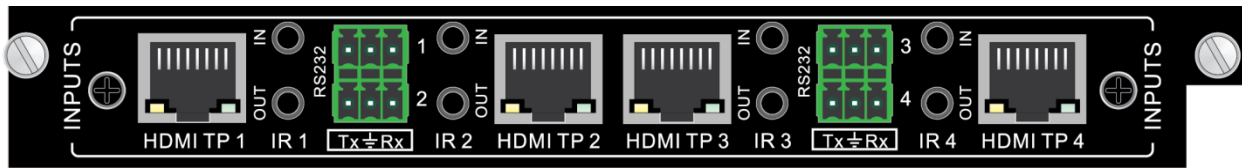

Technical Specifications	
I/O Connections	
HDBaseT Port	Four (4) 8P8C port (Shielded RJ45)
IR In	Four (4) 3.5 mm TS (Requires DIGIB-EYE)
IR Out	Four (4) 3.5 mm TRS (Requires DIGIB-EMT)
RS232	Four (4) 3 pole Euroblock Connectors
Supported Audio, Video and Control	
Maximum Video Compatibility at 70 m	Deep Color 36/30/24 Bit at 1080p
Maximum Video Compatibility at 40 m	Deep Color 48 Bit at 1080p, 3D
Video Compliance	HDMI and HDCP
Embedded Audio	Up to PCM 8 channel, Dolby Digital TrueHD, and DTS-HD Master Audio
IR Carrier Frequency Range	33-55kHz at 5 volts
RS232 Baud Rate	Up to 115200 baud
HDBaseT Signal Characteristics	
Maximum Distance	70 m
Cable Requirements	Solid core shielded Category 5e, Category 6 or greater with TIA/EIA-568B crimp pattern
Bandwidth	10.2 Gbps
Gain	0 dB – 10 dB at 100 MHz
Resolution Range	800x600 – 1920x1200
Signal to Noise Ratio (SNR)	> 70 dB at 100 MHz over 100 m
Return Loss	< -30 dB at 5 KHz
Total Harmonic Distortion (THD)	< 0.005% at 1 KHz
Min-Max Signal Level	< 0.3 V – 1.45 Vp-p
Differential Phase Error	±10° at 135 MHz over 100 m
Chassis and Environmental	
Construction	Plug-in card with keyed black metal plate
Shipping Weight	0.43 kg (0.95 lbs.)
Operating Temperature	0° to +40° C (+32° to +104° F)
Operating Humidity	20% to 90%, Non-condensing
Storage Temperature	-10° to +60° C (+14° to +140° F)
Storage Humidity	20% to 90%, Non-condensing
Other	
Warranty	2 years
Matrix Switcher Compatibility	FLX-8X8A, FLX-88, FLX-1616, FLX-3232
HDBaseT Transmitter (A/V and Control)	DIGI-HD60C-S, DIGI-HDE-S, DIGI-P123, DIGI-P52, ASW-WP
HDBaseT Transmitter (A/V Only)	DIGI-HD70-S
Infrared (IR) Emitter	DIGIB-EMT
Infrared (IR) Receiver	DIGIB-EYE

FLX-HI4A



Technical Specifications	
I/O Connections	
HDMI Input	Four (4) HDMI Type A Receptacle Connector
Analog Audio In	Four (4) 3 pole Euroblock Connectors
Supported Audio and Video	
Maximum Video Compatibility	Deep Color 48/36/30/24 Bit at 1080p, 3D
Video Compliance	HDMI and HDCP (Selectable)
HDMI Audio Compatibility	Up to PCM 8 channel, Dolby Digital TrueHD, and DTS-HD Master Audio
Analog to Digital Conversion Audio Format	PCM 2 Channel 48kHz
Analog Audio	
Performance per Channel	Unbalanced Stereo Audio, -10 dBV nominal
Pinout (Left to Right)	Left (+), Ground, Right (+)
Input Impedance	>10kΩ
Frequency Response	20 Hz to 20 kHz, ±0.5 dB
THD + Noise	< 0.002% from 20 Hz to 20 kHz
HDMI Signal Characteristics	
Bandwidth	340 MHz (10.2 Gbps)
Gain	0 dB
Resolution Range	Up to 1920x1200
Crosstalk	< -50 dB at 5 KHz
Input Level	TMDS 2.9V/3.3V
Chassis and Environmental	
Construction	Plug-in card with keyed black metal plate
Shipping Weight	0.45 kg (1 lbs.)
Operating Temperature	0° to +40° C (+32° to +104° F)
Operating Humidity	20% to 90%, Non-condensing
Storage Temperature	-10° to +60° C (+14° to +140° F)
Storage Humidity	20% to 90%, Non-condensing
Other	
Warranty	2 years
Matrix Switcher Compatibility	FLX-88, FLX-1616, FLX-3232

FLX-R14



Technical Specifications	
I/O Connections	
Analog Video Input	Four (4) Female HD15
Supported Video	
Input Signal Types	VGA-UXGA, RGBHV, RGB, RsGsBs, Component Video, S-Video, & Composite Video
Output Scaling Resolutions	XGA (1024x768), WXGA (1280x800), 720p (1280x720), and 1080p (1920x1080)
Analog Video Input Characteristics	
Bandwidth	340 MHz (10.2 Gbps)
Gain	0 dB
Resolution Range	640x480 – 1920x1080
Crosstalk	< -50 dB at 5 MHz
Input Coupling	AC Coupling Only
Input Level	0.5V – 2.0Vp-p
Chassis and Environmental	
Construction	Plug-in card with keyed black metal plate
Shipping Weight	0.67 kg (1.36 lbs.)
Operating Temperature	0° to +40° C (+32° to +104° F)
Operating Humidity	20% to 90%, Non-condensing
Storage Temperature	-10° to +60° C (+14° to +140° F)
Storage Humidity	20% to 90%, Non-condensing
Included Accessories	
FLX-RBOCA (2 ea)	40 mm (1.57 in.) Male HD15 to three (3) Female RCA Connectors (Red, Green, Blue)
FLX-RBOCB (2 ea)	40 mm (1.57 in.) Male HD15 to one (1) Female RCA Connector (Yellow) and one (1) Female S-Video Connector
Other	
Warranty	2 years
HDMI Matrix Switcher Compatibility	FLX-8X8A, FLX-88, FLX-1616, FLX-3232

FLX-DI4

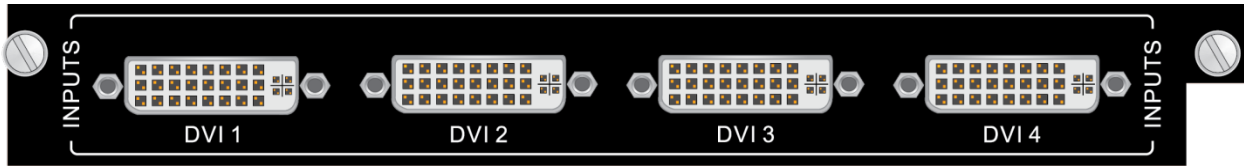

Technical Specifications	
I/O Connections	
Single Link DVI Input	Four (4) Female DVI 24+5
Supported Video	
Input Signal Types	Single Link DVI-D up to 1920x1200
Video Compliance	HDMI and HDCP
EDID and DDC	Actively Buffered; Supports DVI and HDMI standards
DVI Signal Characteristics	
Bandwidth	340 MHz (10.2 Gbps)
Gain	0 dB
Resolution Range	640x480 – 1920x1200
Crosstalk	< -50 dB at 5 KHz
Input Level	TMDS 2.9V/3.3V
Chassis and Environmental	
Construction	Plug-in card with keyed black metal plate
Shipping Weight	0.37 kg (0.81 lbs.)
Operating Temperature	0° to +40° C (+32° to +104° F)
Operating Humidity	20% to 90%, Non-condensing
Storage Temperature	-10° to +60° C (+14° to +140° F)
Storage Humidity	20% to 90%, Non-condensing
Other	
Warranty	2 years
Matrix Switcher Compatibility	FLX-8X8A, FLX-88, FLX-1616, FLX-3232

FLX-BO4A

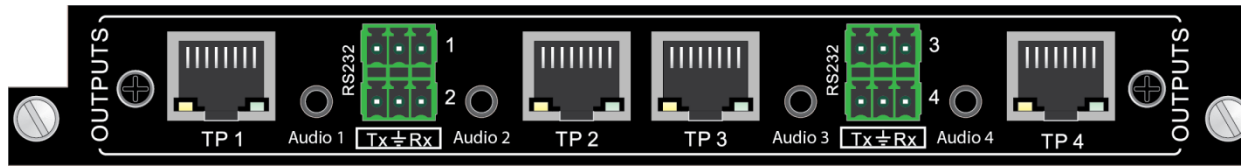

Technical Specifications	
I/O Connections	
HDBaseT Port	Four (4) 8P8C port (Shielded RJ45)
Analog Audio Out	Four (4) 3.5 mm TRS
RS232	Four (4) 3 pole Euroblock Connectors
Supported Audio, Video and Control	
Maximum Video Compatibility at 70 m	Deep Color 36/30/24 Bit at 1080p
Maximum Video Compatibility at 40 m	Deep Color 48 Bit at 1080p, 3D
Video Compliance	HDMI and HDCP
Embedded Audio	Up to PCM 8 channel, Dolby Digital TrueHD, and DTS-HD Master Audio
RS232 Baud Rate	Up to 115200 baud
Analog Audio	
Performance per Channel	Unbalanced Stereo Audio, -10 dBV nominal
Pinout	TIP - Left (+), RING - Right (+), SLEEVE - Ground
Output Impedance	50Ω
Frequency Response	20 Hz to 20 kHz, ±0.5 dB
THD + Noise	< 0.002% from 20 Hz to 20 kHz
HDBaseT Signal Characteristics	
Maximum Distance	70 m
Cable Requirements	Solid core shielded Category 5e, Category 6 or greater with TIA/EIA-568B crimp pattern
Bandwidth	10.2 Gbps
Gain	0 dB – 10 dB at 100 MHz
Resolution Range	800x600 – 1920x1200
Signal to Noise Ratio (SNR)	> 70 dB at 100 MHz over 100 m
Return Loss	< -30 dB at 5 KHz
Total Harmonic Distortion (THD)	< 0.005% at 1 KHz
Min-Max Signal Level	< 0.3 V – 1.45 Vp-p
Differential Phase Error	±10° at 135 MHz over 100 m
Chassis and Environmental	
Construction	Plug-in card with keyed black metal plate
Shipping Weight	0.43 kg (0.95 lbs.)
Operating Temperature	0° to +40° C (+32° to +104° F)
Operating Humidity	20% to 90%, Non-condensing
Storage Temperature	-10° to +60° C (+14° to +140° F)
Storage Humidity	20% to 90%, Non-condensing
Other	
Warranty	2 years
Matrix Switcher Compatibility	FLX-88, FLX-1616, FLX-3232
Compatible Receivers (A/V and Control)	DIGI-HDXL-R, DIGI-HDX-R, DIGI-HDE-R, DIGI-HD60C-R
Compatible Receivers (A/V Only)	DIGI-HD60-R, DIGI-HD70-R

FLX-HO4A

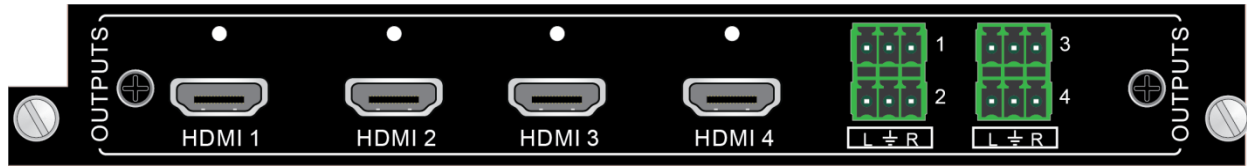

Technical Specifications	
I/O Connections	
HDMI Input	Four (4) HDMI Type A Receptacle Connector
Analog Audio Out	Four (4) 3 pole Euroblock Connectors
Supported Video	
Maximum Video Compatibility	Deep Color 48/36/30/24 Bit at 1080p, 3D
Video Compliance	HDMI and HDCP
Analog Audio	
Performance per Channel	Unbalanced Stereo Audio, -10 dBV nominal
Pinout (Left to Right)	Left (+), Ground, Right (+)
Output Impedance	50Ω
Frequency Response	20 Hz to 20 kHz, ±0.5 dB
THD + Noise	< 0.002% from 20 Hz to 20 kHz
HDMI Signal Characteristics	
Bandwidth	340 MHz (10.2 Gbps)
Gain	0 dB
Resolution Range	Up to 1920x1200
Crosstalk	< -50 dB at 5 KHz
Input Level	TMDS 2.9V/3.3V
Chassis and Environmental	
Construction	Plug-in card with keyed black metal plate
Shipping Weight	0.45 kg (1 lbs.)
Operating Temperature	0° to +40° C (+32° to +104° F)
Operating Humidity	20% to 90%, Non-condensing
Storage Temperature	-10° to +60° C (+14° to +140° F)
Storage Humidity	20% to 90%, Non-condensing
Other	
EDID Copy Mode Selection	Four (4) 2 position DIP switch (one per output)
Warranty	2 years
Matrix Switcher Compatibility	FLX-88, FLX-1616, FLX-3232

FLX-DO4

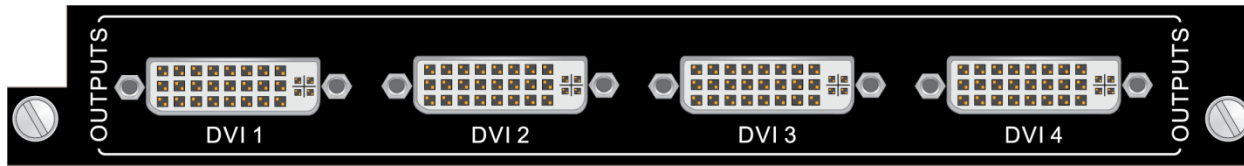

Technical Specifications	
I/O Connections	
Single Link DVI Output	Four (4) Female DVI 24+5
Supported Video	
Output Signal Types	Single Link DVI-D up to 1920x1200
Video Compliance	HDMI and HDCP
EDID and DDC	Actively Buffered; Supports DVI and HDMI standards
DVI Signal Characteristics	
Bandwidth	340 MHz (10.2 Gbps)
Gain	0 dB
Resolution Range	640x480 – 1920x1200
Crosstalk	< -50 dB at 5 KHz
Input Level	TMDS 2.9V/3.3V
Chassis and Environmental	
Construction	Plug-in card with keyed black metal plate
Shipping Weight	0.37 kg (0.81 lbs.)
Operating Temperature	0° to +40° C (+32° to +104° F)
Operating Humidity	20% to 90%, Non-condensing
Storage Temperature	-10° to +60° C (+14° to +140° F)
Storage Humidity	20% to 90%, Non-condensing
Other	
Warranty	2 years
Matrix Switcher Compatibility	FLX-8X8A, FLX-88, FLX-1616, FLX-3232

FLX-BO4A-XL

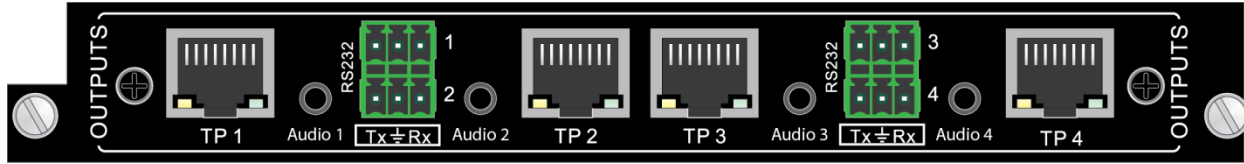

Technical Specifications	
I/O Connections	
HDBaseT Port	Four (4) 8P8C port (Shielded RJ45)
Analog Audio Out	Four (4) 3.5 mm TRS
RS232	Four (4) 3 pole Euroblock Connectors
Supported Audio, Video and Control	
Maximum Video Compatibility at 150 m	30/24 Bit at 1080p
Video Compliance	HDMI and HDCP
Embedded Audio	Up to PCM 8 channel, Dolby Digital TrueHD, and DTS-HD Master Audio
RS232 Baud Rate	Up to 115200 baud
Analog Audio	
Performance per Channel	Unbalanced Stereo Audio, -10 dBV nominal
Pinout	TIP - Left (+), RING - Right (+), SLEEVE - Ground
Output Impedance	50Ω
Frequency Response	20 Hz to 20 kHz, ±0.5 dB
THD + Noise	< 0.002% from 20 Hz to 20 kHz
HDBaseT Signal Characteristics	
Maximum Distance	70 m
Cable Requirements	Solid core shielded Category 5e, Category 6 or greater with TIA/EIA-568B crimp pattern
Bandwidth	10.2 Gbps
Gain	0 dB – 10 dB at 100 MHz
Resolution Range	800x600 – 1920x1200
Signal to Noise Ratio (SNR)	> 70 dB at 100 MHz over 100 m
Return Loss	< -30 dB at 5 KHz
Total Harmonic Distortion (THD)	< 0.005% at 1 KHz
Min-Max Signal Level	< 0.3 V – 1.45 Vp-p
Differential Phase Error	±10° at 135 MHz over 100 m
Chassis and Environmental	
Construction	Plug-in card with keyed black metal plate
Shipping Weight	0.43 kg (0.95 lbs.)
Operating Temperature	0° to +40° C (+32° to +104° F)
Operating Humidity	20% to 90%, Non-condensing
Storage Temperature	-10° to +60° C (+14° to +140° F)
Storage Humidity	20% to 90%, Non-condensing
Other	
Warranty	2 years
Matrix Switcher Compatibility	FLX-88, FLX-1616, FLX-3232
Compatible Receivers (A/V and Control)	DIGI-HDXL-R

DIGIB-EMT



Technical Specifications	
Signal Characteristics	
Wide-Band Infrared (IR)	30 KHz to 56 KHz at 5V DC reference
Physical Characteristics	
Material, Emitter Housing	Deep red translucent plastic
Dimensions, Emitter Housing	6 mm x 9.5 mm x 15 mm (0.24 in. x 0.37 in. x 0.59 in.)
Cable Length	2 m (6.56 ft)
Cable Connector	3.5 mm (1/8 in.) mono (TS) plug
Shipping Weight	0.5 lbs. (0.23kg)
Other	
Warranty	2 years
What's in the Box	(4) DIGIB-EMT
Compatible Devices	FLX-BI4, FLX-BO4, DIGI-HDE-S, DIGI-HDE-R, DIGI-HD60C-S, DIGI-HD60C-R, DIGI-HD-IR3-S, DIGI-HD-IR3-R, DIGI-HD-IR3-WP-S, DIGI-HD-IR3-WP-R, DIGI-HD-8X8, DIGI-HD-4X8, DIGI-HD-4X4, DIGI-HD-4X2

DIGIB-EYE



Technical Specifications	
Signal Characteristics	
Wide-Band Infrared (IR)	30 KHz to 56 KHz at 5V DC reference
Physical Characteristics	
Material, Emitter Housing	Black plastic housing; smoke gray lens housing
Dimensions, Emitter Housing	13.5 mm x 9 mm x 29.5 mm (0.53 in. x 0.35 in. x 1.16 in.)
Cable Length	1 m (3.28 ft)
Cable Connector	3.5 mm (1/8 in.) stereo (TRS) plug
Shipping Weight	0.5 lbs. (0.23kg)
Other	
Warranty	2 years
What's in the Box	(1) DIGIB-EYE (hardware not included)
Compatible Devices	FLX-BI4, FLX-BO4, DIGI-HDE-S, DIGI-HDE-R, DIGI-HD60C-S, DIGI-HD60C-R, DIGI-HD-IR3-S, DIGI-HD-IR3-R, DIGI-HD-IR3-WP-S, DIGI-HD-IR3-WP-R

Thank you for your purchase.

Please contact us with your questions and comments.

Intelix

8001 Terrace Ave, Ste 201
Middleton, WI 53562

Phone: 608-831-0880
Toll Free: 866-462-8649
Fax: 608-831-1833

www.intelix.com
supportlibav@libav.com