

DIGITALINX

VALUE-ENGINEERED DIGITAL SOLUTIONS

DL-AS31-2H1DP Installation Guide

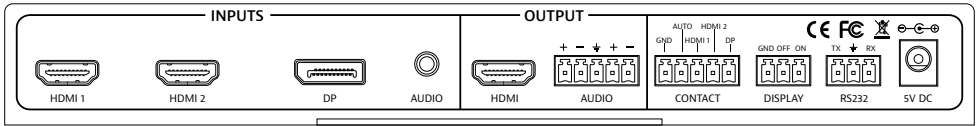

DL-AS31-2H1DP

3x1 Auto-Switcher



Safety Precautions

To insure the best from the product, please read all instructions carefully before using the device. Save this manual for further reference.

- Unpack the equipment carefully and save the original box and packing material for possible future shipment.
- Follow basic safety precautions to reduce the risk of fire, electrical shock and injury to persons.
- Do not dismantle the housing or modify the module. It may result in electrical shock or burn.
- Using supplies or parts not meeting the products' specifications may cause damage, deterioration or malfunction.
- Refer all servicing to qualified service personnel.
- To prevent fire or shock hazard, do not expose the unit to rain, moisture or install this product near water.
- Do not put any heavy items on the extension cable in case of extrusion.
- Do not remove the housing of the device as opening or removing housing may expose you to dangerous voltage or other hazards.
- Install the device in a place with good ventilation to avoid damage caused by overheating.
- Keep the module away from liquids.
- Spillage into the housing may result in fire, electrical shock, or equipment damage. If an object or liquid falls or spills on to the housing, unplug the module immediately.
- Do not use liquid or aerosol cleaners to clean this unit. Always unplug the power to the device before cleaning.
- Unplug the power cord when left unused for a long period of time.
- Information on disposal for scrapped devices: do not burn or mix with general household waste. Please treat them as normal electrical waste and recycle the devices properly.

The DL-AS31-2H1DP is a multiformat auto-switcher with two HDMI inputs, one DisplayPort with analog audio input, one HDMI output, and one balanced analog audio output. This auto-switcher supports HDMI and DisplayPort video resolutions up to 4Kx2K at 30 Hz and multichannel audio. In addition to passing EDID information from the display, there are multiple built-in EDID settings to simplify an installation. The DL-AS31-2H1DP will de-embed the digital audio from the HDMI output signal, and output it via the balanced analog audio output port.

When in auto-switch mode, the DL-AS31-2H1DP will switch to a signal input as soon as a new source is connected. When the active source is removed, the switcher will select the first source on the lowest numbered input. The DL-AS31-2H1DP may also be controlled via RS232 commands or by contact closures on the rear of the switcher.

Front Panel

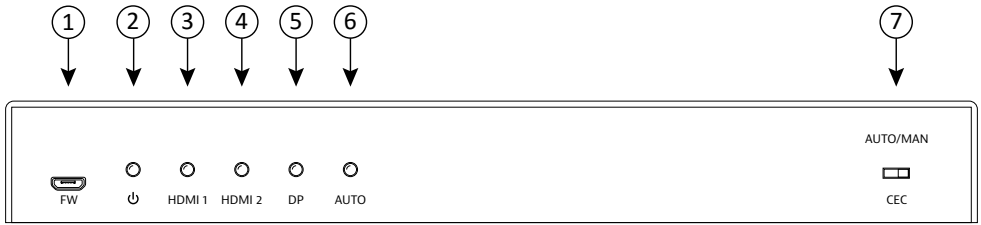

1. Firmware Update Port
2. Power LED
3. HDMI 1 Activity LED
4. HDMI 2 Activity LED
5. DisplayPort Activity LED
6. Auto-Switching Mode LED
7. CEC Mode Switch

Rear Panel

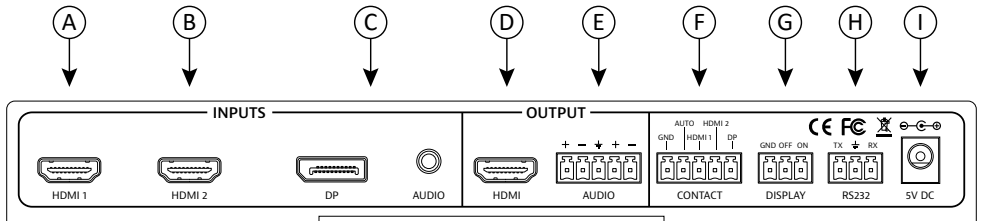

- A. HDMI 1 Input
- B. HDMI 2 Input
- C. DisplayPort Input with Analog Audio
- D. HDMI Output
- E. Balanced Analog Audio Output
- F. Source Select Contact Closures
- G. Display CEC On/Off Contact Closures
- H. RS232 Control Port
- I. 5V DC Input

Included Accessories

- Installation guide
- Power supply with AC adapters
- RS232 cable
- 5-pin terminal blocks (2 ea)
- 3-pin terminal blocks (2 ea)
- rubber feet
- mounting "L" brackets (2 ea)
- mounting screws (4 ea)

Installation Instructions

1. Verify all components included with the switcher are present before installation.
2. If the switcher will be permanently mounted to a surface, attach the included mounting brackets with the supplied screws.
3. If the switcher will be sitting on a shelf, attach the included rubber feet to the bottom of the unit.
4. Turn off power and disconnect the audio/video equipment by following the manufacturer's instructions.
5. If the switcher needs to use a preset EDID instead of the EDID of the connected display, send the appropriate RS232 EDID command to the DL-AS31.
6. Connect HDMI signal cables between the HDMI sources and the HDMI 1 and HDMI 2 Input ports.
7. Connect a DP signal cable between the DP source and the DP Input port.
8. Connect an audio signal cable between the audio source and the Audio Input port for DisplayPort devices that do not support embedded audio.
9. Connect an HDMI cable between the display and the HDMI Output port.
10. Connect an analog audio cable between an audio amplifier and the Audio Output port.
11. Connect an RS232 cable between the control system and the RS232 port. The distance between PC and the switcher should be within 100m.
12. If the switcher will be controlled via contact closure, connect the controller to the CONTACT and DISPLAY ports.
13. Connect the included power supply to the switcher.
14. Power on attached audio/video devices.

Source Select Contact Closure Wiring

With AUTO and GND shorted, the DL-AS31 will automatically switch to the next active input. Momentary contact closure connections will manually switch the source input.

Automatic Switching:

Manual Switching:

Automatic Switching with Manual Override

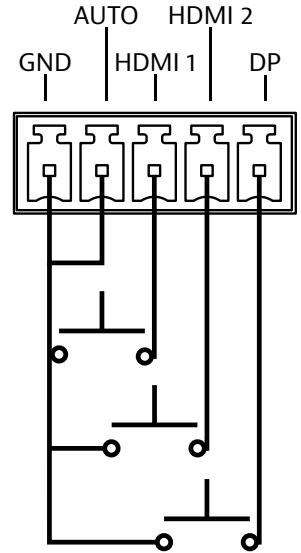
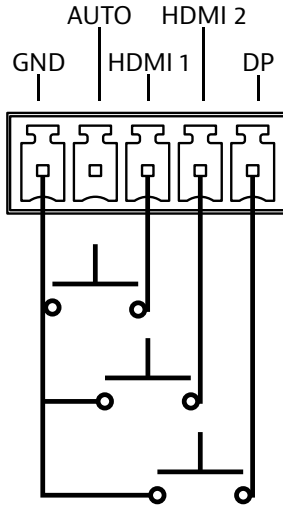
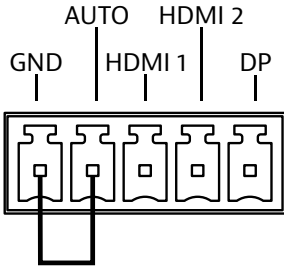

Input Selection

Automatic Switching:

To enable automatic switching, place a jumper between the Gnd and Auto connections on the Source Select Contact Closures. When in auto-switch mode, the DL-AS31 will switch according to the following rules:

New Input: Upon detecting a new input, the switcher will automatically select the new input.

Reboot: Once power is restored to the switcher, it will automatically reconnect the active input. If all inputs are active, it will switch to the HDMI 1 input.

Source Removed: When an active source is removed, the DL-AS31 will switch to the first available active input.

Manual Switching:

To enable manual switching, select the input of the DL-AS31 by using one of the following methods:

Contact Closure: Make a contact closure between the desired source and GND contacts.

RS232: Transmit the SET HDMI 1, SET HDMI 2 or SET DP RS232 commands.

Display On/Off

Automatic display on:

To automatically turn on the display when an active input is connected, slide the CEC mode switch to the Auto position. When in Auto mode, the DL-AS31 will turn on the display once an active source has been connected.

Automatic display off:

To automatically turn off the display when no active input is connected, slide the CEC mode switch to the Auto position. When in Auto mode, the DL-AS31 will turn off the display after no sources have been connected for three (3) minutes. To increase the time before power off, send the `CEC OFF XX` command via RS232.

Manual display on/off:

To manually turn on or off the display, slide the CEC mode switch to the Man position. When in Man mode, the DL-AS21C can turn on and off the display with active sources connected to the inputs.

Contact Closure: Make a contact closure between the ON and GND contacts or the OFF and ground contacts.

RS232: Transmit the `DISPLAY ON` or `DISPLAY OFF` RS232 commands.

Display CEC Contact Closure Wiring

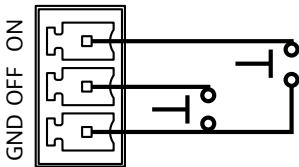

Analog Audio Output Wiring

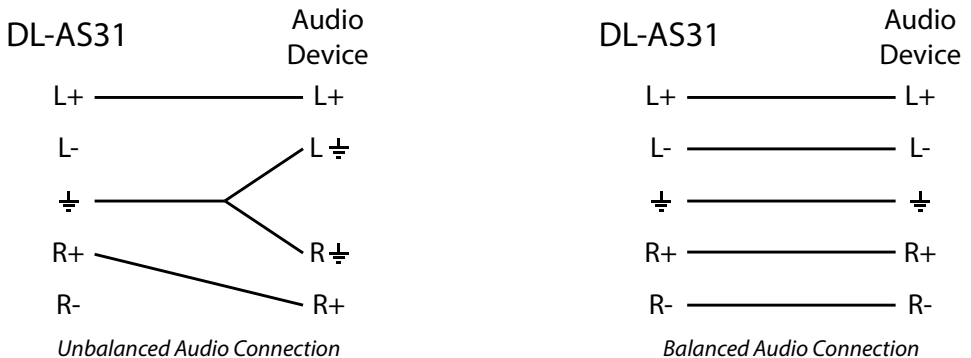

RS232 Control

RS232 Settings: 9600 baud, 8 Data bits, 1 Stop bit, Parity = None

A carriage return and line feed must follow all RS232 commands. A carriage return and line feed will follow all responses.

Input Switching

Description	Command	Response
Select HDMI 1 input	SET HDMI 1	SET HDMI1! Switch to HDMI1!
Select HDMI 2 input	SET HDMI 2	SET HDMI2! Switch to HDMI2!
Select DP input	SET DP	SET DP! Switch to DP!
Get active input	GET IN	GET IN! HDMI1! OR GET IN! HDMI2! OR GET IN! DP!

HDCP Configuration

Description	Command	Response
Turn on HDCP Compliance on active input	HDCP ON	HDCP ON!
Turn off HDCP Compliance on active input	HDCP OFF	HDCP OFF!
Query HDCP Status	GET HDCP	HDCP ON! OR HDCP OFF!

DisplayPort Audio Configuration

Description	Command	Response
Use embedded audio	AUDIO INTERN	AUDIO INTERN!
Use external audio	AUDIO EXTERN	AUDIO EXTERN!
Query DisplayPort audio configuration	GET AUDIO	AUDIO INTERN! OR AUDIO EXTERN!

CEC Commands

Description	Command	Response
Turn display (sink) on	DISPLAY ON	DISPLAY ON
Turn display (sink) off	DISPLAY OFF	DISPLAY OFF
Set CEC auto off time (XX = minutes) (default = 03)	CEC OFF XX	CEC OFF Delay XX minutes
Query CEC auto off time	GET CEC	CEC OFF Delay XX minutes
Query CEC mode	GET CECMODE	CEC AUTO! OR CEC Manual!

HDMI and DisplayPort EDID

Description	Command	Response
UHD/30 (3840x2160 at 30 Hz)	EDID UHD	EDID:UHD!
WUXGA at 60 Hz (1920x1200 at 60 Hz)	EDID WUXGA	EDID:WUXGA!
Full HD at 60 Hz (1920x1080 at 60 Hz)	EDID FHD	EDID:FHD!
UXGA at 60 Hz (1600x1200 at 60 Hz)	EDID UXGA	EDID:UXGA!
SXGAP at 60 Hz (1400x1050 at 60 Hz)	EDID SXGAP	EDID:SXGAP!
WXGA2 at 60 Hz (1360x768 at 60 Hz)	EDID WXGA2	EDID:WXGA2!
WXGA at 60 Hz (1280x800 at 60 Hz)	EDID WXGA	EDID:WXGA!
HD at 60 Hz (1280x720 at 60 Hz)	EDID HD	EDID:HD!
XGA at 60 Hz (1024x768 at 60 Hz)	EDID XGA	EDID:XGA!
EDID pass through	EDID PT	EDID :PT!
Query EDID	GET EDID	EDID

Other Commands

Description	Command	Response
Enter low power mode	STANDBY	STANDBY!
Exit low power mode	WAKE	WAKE
Get firmware version	REV?	VX.X.X
Query product model	MODEL?	DL-AS31-2H1DP
Reset to factory defaults (EDID at FHD; CEC at 3 mins)	RST	System Initializing..... Initialization Finished Input: HDMI1 VX.X.X AUTO ON!

Technical Specifications

I/O Connections	
HDMI Inputs	Two (2) HDMI Type A Receptacle
DisplayPort Input	One (1) Full Size DisplayPort Female Receptacle
Audio Input	One (1) 3.5mm TRS Jack
HDMI Output	One (1) HDMI Type A Receptacle
Audio Output	One (1) 5-pin Removable Terminal Block
Input Select Contact Closures	One (1) 5-pin Removable Terminal Block
Manual CEC Contact Closures	One (1) 3-pin Removable Terminal Block
RS232	One (1) 3-pin Removable Terminal Block
DC 5V Power	One (1) 5.5 mm Outside Diameter, 2.1 mm Inside Diameter Barrel
CEC Switch	One (1) 3mm Microswitch
Firmware	One (1) Micro-B Receptacle
Supported Audio and Video	
Maximum Video Compatibility	Deep Color 48/36/30/24 Bit at 1080p and 2160p/30
Video Compliance	HDMI1.4, HDCP1.4, CEC (Consumer Electronics Control)
HDMI and DisplayPort Video Signal Resolution	4096x2160@30Hz, 3840x2160@24/25/30Hz, 1920x1080@24/25/30/50/60Hz, 1920x1080@50/60Hz, 1920x1080i@50/60Hz, 1600x900@60Hz, 1366x768Hz@60Hz, 1280x720Hz@60Hz, 1920x1200@60Hz, 1680x1050@60Hz, 1440x900@60Hz, 1360x768@60Hz, 1280x800@60Hz, 1600x1200@60Hz, 1400x1050@60Hz, 1280x1204@60Hz, 1024x768@60Hz, 800x600@60Hz, 640x480@60Hz
HDMI Embedded Audio	PCM/Dolby Digital/DTS/DTS-HD
External Audio Signal	Stereo audio
Output Audio Signal	Balanced analog audio, compatible with unbalanced analog audio.
Output Audio Signal to Noise Ratio	SNR≥85dB
Output Audio Frequency Response	20 Hz to 20 kHz
Input DDC Signal	5.0 volts p-p (TTL)
Input Video Signal	0.5 to 1.0 volts p-p
Maximum Passive Cable Length	5 m (16 ft)
RS232 Baud Rate	9600 baud

Chassis and Environmental	
Enclosure	Painted aluminum
Dimensions (W x H x D)	240 mm x 100mm x 30 mm (9.45 in x 3.94 in x 1.18 in)
Shipping Weight	0.85 kg (1.87 lbs.)
Operating Temperature (Environment)	0° to +40° C (+32° to +104° F)
Operating Temperature (Chassis)	31° C (88° F) (S); 38° C (100° F) (R)
Operating Humidity (Environment)	20% to 90%, Non-condensing
Storage Temperature (Environment)	-10° to +60° C (+14° to +140° F)
Storage Humidity (Environment)	20% to 90%, Non-condensing
Power, ESD, and Regulatory	
Maximum Power Consumption	5 watts
Power Supply Input Voltage	100-240V AC at 50/60 Hz
Power Supply Output Rating	DC5V at 3 A
ESD Protection	Contact discharge: ±15kV; Air discharge: ±8kV
Device Regulatory	CE, RoHS
Power Supply Regulatory	CE, RoHS, TUV, UL, SGS
Other	
Standard Warranty	2 Years
Diagnostic Indicators	Power, Source Mode, Selected Input.
Included Accessories	Installation guide, power supply with AC adapters (AU, EU, UK, and US), RS232 cable, 5-pin terminal blocks (2 ea), 3-pin terminal blocks (2 ea), rubber feet, mounting "L" brackets (2 ea), mounting screws (4 ea)

Distances and picture quality may be affected by cable grade, cable quality, source and destination equipment, RF and electrical interference, and cable patches.



LIBERTY
AV SOLUTIONS

A SUBSIDIARY OF WESCO DISTRIBUTION, INC.

11675 Ridgeline Dr.

Colorado Springs, CO 80921

Toll-Free: 800-530-8998

Fax: 719-260-0075

www.libav.com

rev 160323