



DIGITALINX

BY LIBERTY AV SOLUTIONS

DL-SC41U-TX Owners Manual



Important Safety Instructions

- » Please completely read and verify you understand all instructions in this manual before operating this equipment.
- » Keep these instructions in a safe, accessible place for future reference.
- » Heed all warnings.
- » Follow all instructions.
- » Do not use this apparatus near water.
- » Clean only with a dry cloth.
- » Do not install near any heat sources such as radiators, heat registers, stoves, or other apparatus (including amplifiers) that produce heat.
- » Use only accessories specified or recommended by Intelix.
- » Explanation of graphical symbols:

◊ Lightning bolt/flash symbol: the lightning bolt/flash and arrowhead within an equilateral triangle symbol is intended to alert the user to the presence of uninsulated “dangerous voltage” within the product enclosure which may be of sufficient magnitude to constitute a risk of shock to a person or persons.



◊ Exclamation point symbol: the exclamation point within an equilateral triangle symbol is intended to alert the user to the presence of important operating and maintenance (servicing) instructions in the literature accompanying the product.



- » **WARNING: TO REDUCE THE RISK OF FIRE OR ELECTRIC SHOCK, DO NOT EXPOSE THIS APPARATUS TO RAIN OR MOISTURE AND OBJECTS FILLED WITH LIQUIDS, SUCH AS VASES, SHOULD NOT BE PLACED ON THIS APPARATUS.**
- » Use the mains plug to disconnect the apparatus from the mains.
- » **THE MAINS PLUG OF THE POWER CORD MUST REMAIN READILY ACCESSIBLE.**
- » Do not defeat the safety purpose polarized or grounding-type plug. A polarized plug has two blades with one wider than the other. A grounding-type plug has two blades and a third grounding prong. The wide blade or the third prong is provided for your safety. If the provided plug does not fit into your outlet, consult an electrician for replacement of your obsolete outlet. **Caution! To reduce the risk of electrical shock, grounding of the center pin of this plug must be maintained.**
- » Protect the power cord from being walked on or pinched particularly at the plugs, convenience receptacles, and the point where they exit from the apparatus.
- » Do not block the air ventilation openings. Only mount the equipment per Intelix’s instructions.
- » Use only with the cart, stand, table, or rack specified by Intelix or sold with the equipment. When/if a cart is used, use caution when moving the cart/equipment combination to avoid injury from tip-over.
- » Unplug this apparatus during lightning storms or when unused for long periods of time.
- » **Caution! Shock Hazard. Do not open the unit.**
- » Refer to qualified service personnel. Servicing is required when the apparatus has been damaged in any way, such as power supply cord or plug is damaged, liquid has been spilled or objects have fallen into the apparatus, the apparatus has been exposed to rain or moisture, does not operate normally, or has been dropped.



Table of Contents

Product Overview	4
Product Contents	4
Front and Rear Panels	5
<i>Front Panel</i>	5
<i>Rear Panel</i>	6
Installation Instructions	7
<i>Mount the Matrix</i>	7
<i>Connect Sources</i>	7
Video Inputs.....	7
<i>Connect Displays</i>	7
HDMI Outputs.....	7
HDBaseT Output (Optional).....	7
<i>Connecting Control</i>	8
RS232 Port Wiring.....	8
<i>Connect Ethernet (Web Browser) Control (Optional)</i>	9
Router Connection.....	9
Crossover Cable Connection.....	9
Web Browser Control.....	9
<i>Applying Power</i>	10
HDBaseT Cabling Requirements	10
A/V Diagram	11
<i>Standalone</i>	11
<i>With Optional HDBaseT Receiver</i>	12
Web GUI Control / System Settings	13
<i>Switcher Control</i>	13
Connecting to Web GUI Control.....	13
A/V Switching.....	14
RS232 Display Control Settings.....	15
Auto Display ON/OFF Settings.....	16
USB Host Switching Settings.....	17
Edid Management.....	18
Relay Configuration.....	19
Renaming Inputs.....	20
Network Settings.....	21
Security Settings.....	22
System Settings.....	23
RS232 and TCP/IP Control	24
<i>A/V Routing</i>	24
<i>USB Host Routing</i>	25
<i>CEC / RS232 Display Control</i>	26
<i>Relay Control</i>	26
<i>System Commands</i>	27
Technical Specifications	28

Product Overview

The DigitaLinx DL-SC41U-TX is a 4x1 multi format A/V presentation auto switcher that supports video resolutions up to 4K@60Hz 4:4:4 8bit deep color, is HDCP 2.2 compliant and has a built in USB 3.0 switching hub for control and integration of USB devices such as USB cameras and microphones. The switcher features four video inputs; (2) HDMI, (1) Display Port and (1) USB-C. The USB-C input supports video, data (USB host) and power charging up to 40w. There is a 2 port USB client hub built with 2 USB host ports that can be switched independently or can be assigned to follow a video input so when the video input is triggered or switched, the defined USB host port will also switch. The switcher features two matrix outputs; HDMI and HDBaseT 2.0. The built in HDBaseT 2.0 transmitter output supports long distance transport of audio, video and High Speed USB 2.0 signals up to 190Mbps up to 70 meters / 232' using one category cable. The switcher is compatible with the DL-SCU-RX HDBaseT 2.0 receiver (sold separately) and the receiver can supply power to the DL-SC41U-TX remotely when used in this configuration. **NOTE:** When using the DL-SCU-RX HDBaseT 2.0 receiver, it will not provide power charging to the USB-C input unless the DL-SC41U-TX is also powered.

The DL-SC41U-TX gives you the ability to automate the display power ON by using pre-loaded RS232 commands whenever a video signal is introduced to the system using any A/V input. It will also turn the display power OFF after a specified amount of time has passed when no video signal or switching activity is present. For a complete list of programming commands to automate display power status, please see the complete owners manual online at www.libav.com or by using the QR code on the print page of this guide.

The DL-SC41U-TX can be controlled via front panel buttons or by API commands using RS232 or Ethernet. A web server / GUI is built in that features A/V and USB switching control, automatic display control and input EDID management.

The DL-SC41U-TX is ideal for software based video teleconference rooms that require the consolidation and sync of A/V and USB signals from a laptop or room PC.

NOTE: The DL-SC41U-TX switcher can be used as a standalone switcher or paired with an HDBaseT receiver. The DL-SCU-RX HDBaseT 2.0 receiver (sold separately) is required to complete an extension circuit. When using the DL-SCU-RX, only USB 2.0 Full Speed devices can be used on the receiver.

Product Contents

- DL-SC41U-TX 4X1 HDMI / USB Switcher
- (1) Quick Install Guide
- (1) 3 pin Phoenix Male Connector
- (4) Plastic Cushions
- (2) Mounting clips with 4 screws
- DC24V Power Supply with US, UK, EU and AU adapter plugs

Front and Rear Panels

Front Panel

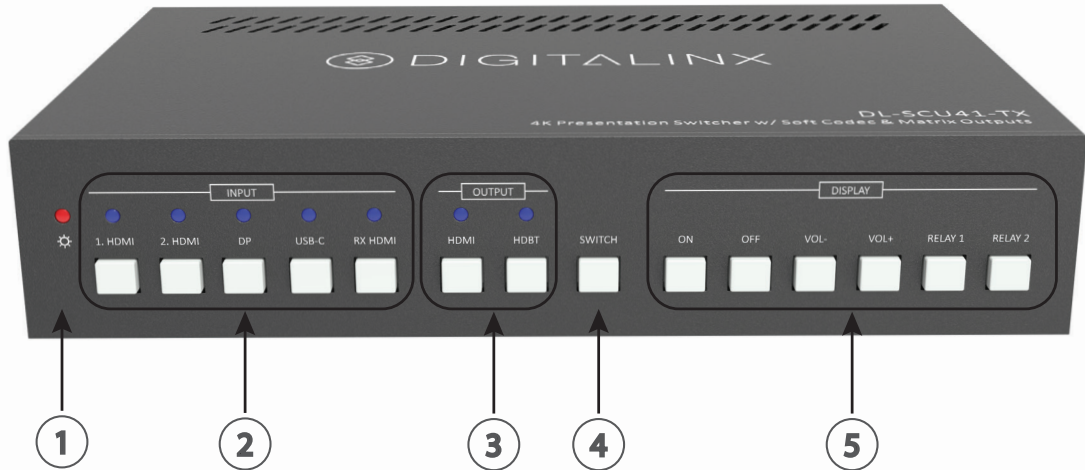

1. **POWER LED** - Illuminated red when power is applied
2. **INPUT** - A/V source selector and input LEDs
 - **NOTE:** The RX HDMI can only be used when paired with the DL-SCU-RX HDBaseT receiver
3. **OUTPUT** - Output selector and output LEDs
4. **SWITCH** - A/V switch selector
 - To route an input to an output, select the *INPUT*, then the *OUTPUT* then press *SWITCH*. By default the DL-SC41U-TX is set to auto switching mode.
5. **DISPLAY** - Display control buttons, triggers CEC / RS232 commands
 - ON: Turns display ON
 - OFF: Turns display OFF
 - VOL-: Turns display volume down
 - VOL+: Turns display volume up
 - RELAY 1: Turns relay 1 state ON/OFF
 - RELAY 2: Turns relay 2 state ON/OFF

NOTE: The RELAY 1/2 buttons can only be used when paired with the optional DL-SCU-RX HDBaseT receiver (not included)

Rear Panel

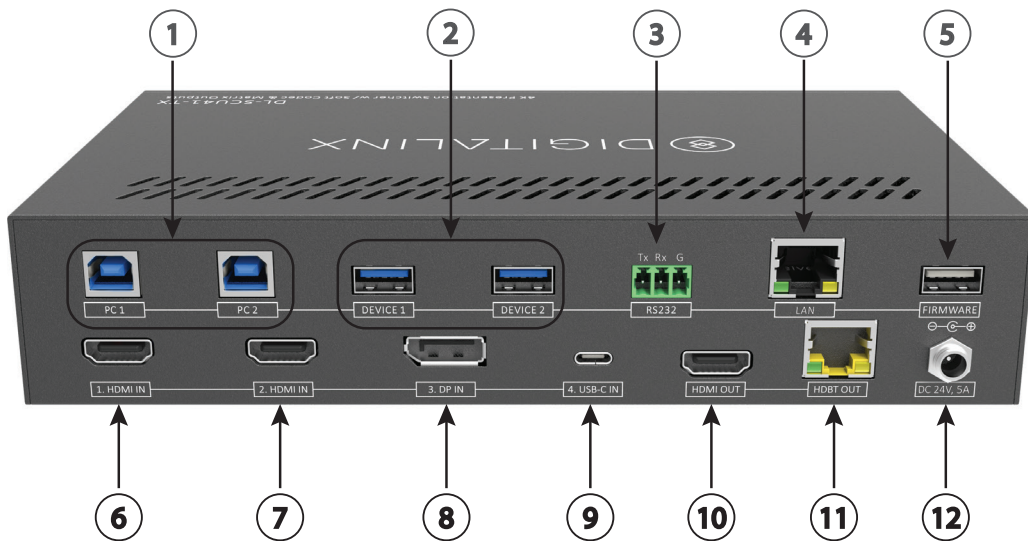

1. PC1 / PC2 - USB B Host ports

NOTE: By default PC1 is set to follow HDMI 1 video input, PC2 is set to follow HDMI 2 video input. This can be changed in the web GUI settings. See owners manual for complete instructions.

2. Device 1 / Device 2 - USB A Client ports

3. RS232 - Phoenix connector for RS232 system control

4. LAN - RJ45 connector for Ethernet system control

5. FIRMWARE - USB A port for firmware updates

6. 1. HDMI IN - HDMI input 1

7. 2. HDMI IN - HDMI input 2

8. 3. DP IN - Display Port input

9. 4. USB-C IN - USB C input, support A/V, data and power charging up to 40 watts

NOTE: The DL-SC41U-TX USB-C input supports ALT-DP mode for video, to ensure a source is compatible with the DL-SC41U-TX check the sources capability of supporting this mode.

10. HDMI OUT - HDMI output

11. HDBT OUT - 70M / 232' HDBaseT 2.0 transmitter output

12. DC24V - Power supply input

Installation Instructions

Mount the Matrix

At least 2 inches of free air space is required on both sides of the DL-SC41U-TX for proper side ventilation. Avoid mounting the DL-SC41U-TX near a power amplifier or any other source of significant heat.

Connect Sources

Video Inputs

Connect source devices to the HDMI, Display Port, or USB-C inputs. When using HDMI cables for source inputs, use a High Speed HDMI cable that is less than or equal to 5 meters in length for 4k60 signals and 8 meters for 1080p signals.

When connecting a source device to the USB-C input using a USB-C cable, be sure the USB-C cable is capable of supporting video and is no longer than 2 meters (6.6') in total length. The DL-SC41U-TX USB-C input supports ALT-DP mode for video, to ensure a laptop is compatible with the DL-SC41U-TX check the laptops capability of supporting this mode.

Note that not all laptops with USB-C port options will support video or more specifically ALT-DP video mode.

Connect Displays

HDMI Outputs

Connect display devices to the HDMI 1 and 2 output using a High Speed HDMI cable that is less than or equal to 5 meters in length for 4k60 signals and 8 meters for 1080p signals.

HDBaseT Output (Optional)

Connect a solid core CAT6 F/UTP rated category cable to the DL-SC41U-TX HDBaseT output and the optional HDBaseT receiver (DL-SCU-RX). Use TIA/EIA-568B wiring for Category 6 connection between the DL-SC41U-TX and the receiver. See page 10 for *HDBaseT Cabling Requirements*.

Connect a display device to the HDMI output of the HDBaseT receiver using a High Speed HDMI cable that is less than or equal to 5 meters in length for 4k60 signals and 8 meters for 1080p signals.

Connecting Control

RS232 Port Wiring

Connect a control system to the DL-SC41U-TX via RS232 for switcher control.

RS232 Wiring

Connect the system controller RX signal to TX on the DL-SC41U-TX, then connect the controllers TX signal to RX on the DL-SC41U-TX.

RS232 Settings:

- 9600 baud
- 8 Data Bits
- 1 Stop Bit
- Parity = none

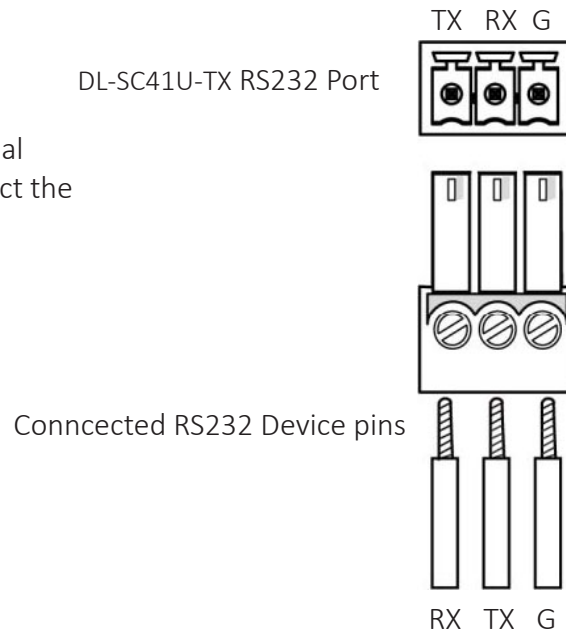

Connect Ethernet (Web Browser) Control (Optional)

The DL-SC41U-TX can be controlled via Ethernet through a web browser interface.

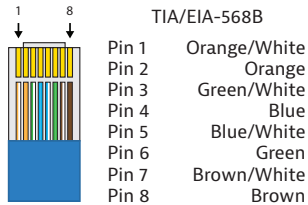

The TCP/IP port requires a standard straight-through Category 5 or greater cable with the TIA/EIA-568B crimp pattern for optimal operation.

The default settings for the TCP/IP port are:
IP address: 192.168.0.178, Telnet Port 4001

Connect the Ethernet cable between to the switcher and a router with a straight-through cable or between the matrix and a computer with a crossover cable.

Router Connection

1. Configure the router to use the same IP range as the matrix, such as 192.168.0.1.
2. Connect the computer to the router.
3. Connect the DL-SC41U-TX to the router

Web Browser Control

The DL-SC41U-TX includes a web portal to allow control of the matrix via a standard web browser. The IP address is the same address that is used for TCP/IP control.

Applying Power

Connect the included power supply to the DL-SC41U-TX power port, connect the IEC power cord connected to power supply to a power source.

HDBaseT Cabling Requirements

HDBaseT Cabling

To ensure proper performance of the DL-SC41U-TX, it is recommended that you use solid core, shielded Category 6 F/UTP cabling at a minimum. Category 5e F/UTP may perform well but may not support power over HDBaseT reliably over longer distances.



When using shielded category cabling *ALWAYS*...

-use shielded connectors
-properly ground the category cable

For optimized HDBaseT performance use the following Liberty Wire and Cable branded cabling;

Category 6 plenum; **24-4P-P-L6SH**

Category 6A plenum; **24-4P-P-L6ASH**

Category 6 NON-plenum; **24-4P-L6SH**

Category 6A NON-plenum; **24-4P-L6ASH**

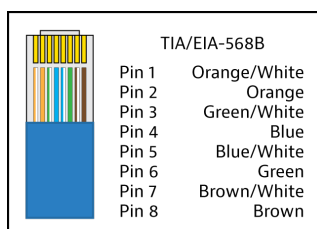

Twisted Pair Wiring

Use TIA/EIA-568B wiring for Category 6 connection between send and receive units.

A/V Diagram

Standalone

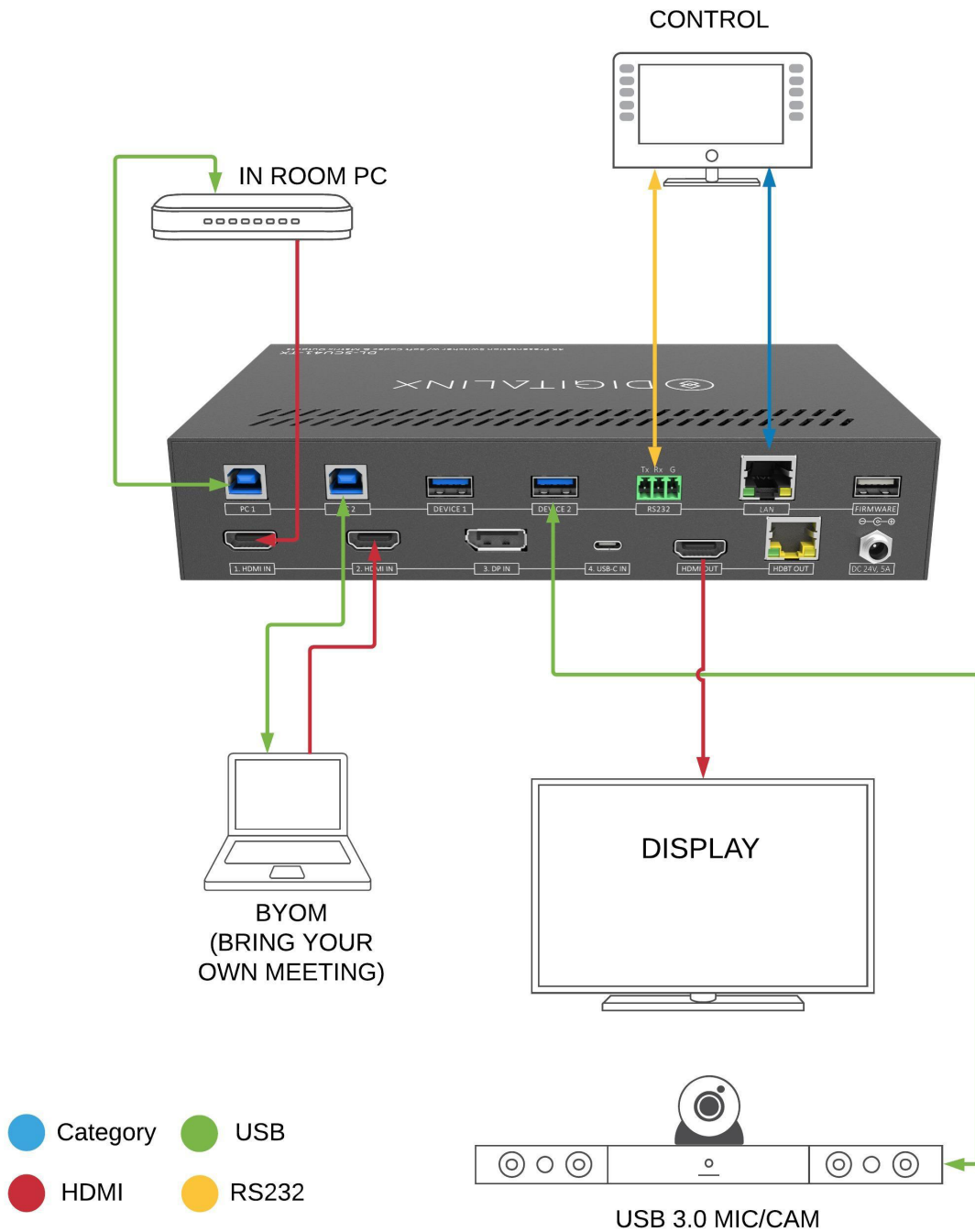

With Optional HDBaseT Receiver

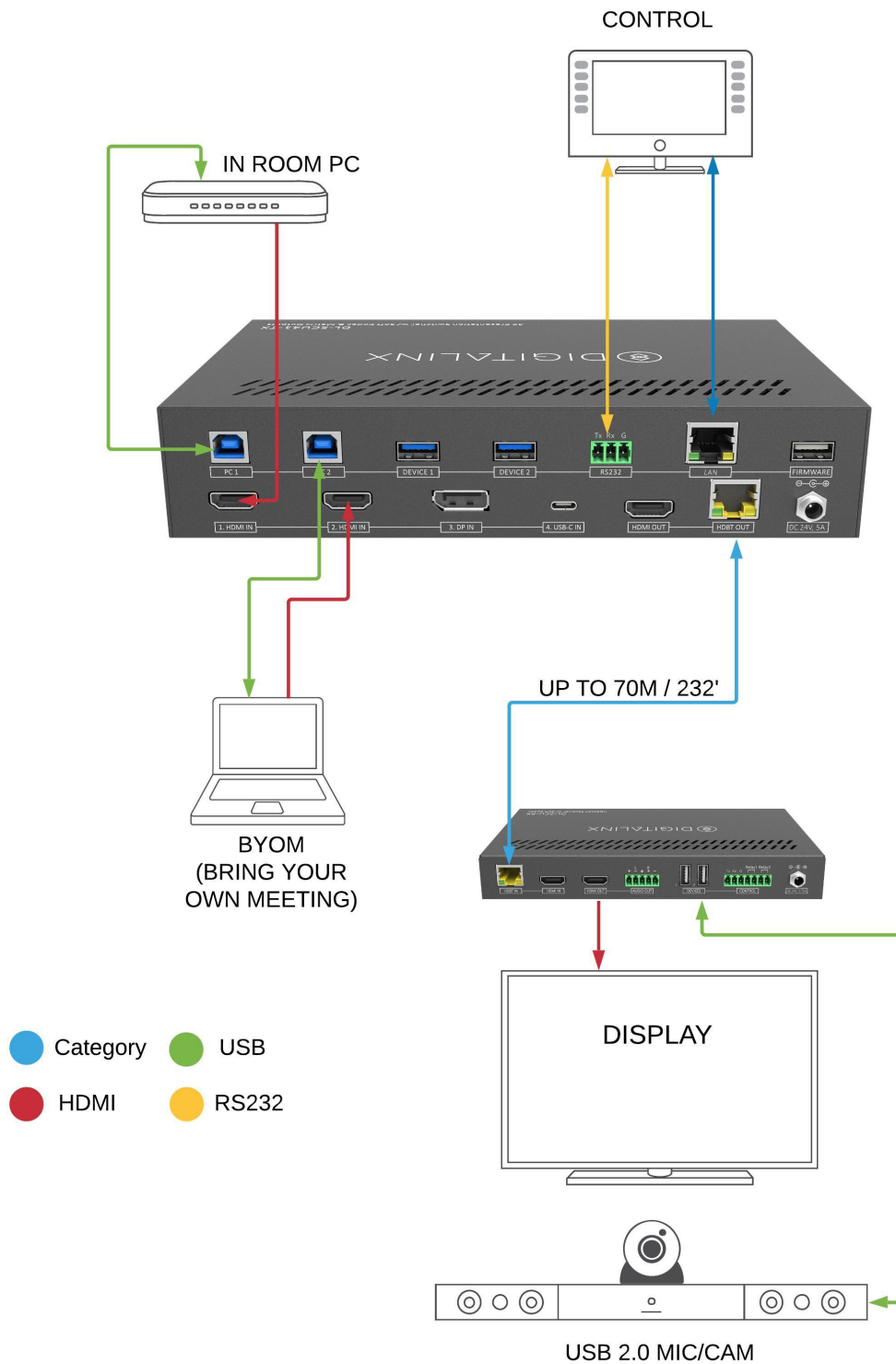

Web GUI Control / System Settings

Switcher Control

Connecting to Web GUI Control

Network a PC computer and the DL-SCU41-TX then open a web browser and type in IP address of the DL-SCU41-TX. The default IP address is 192.168.0.178. Be sure the computer you are using to connect to the DL-SCU41-TX is in the same IP range to access the web GUI / server.

The login screen will appear. The default user name and password is *admin*

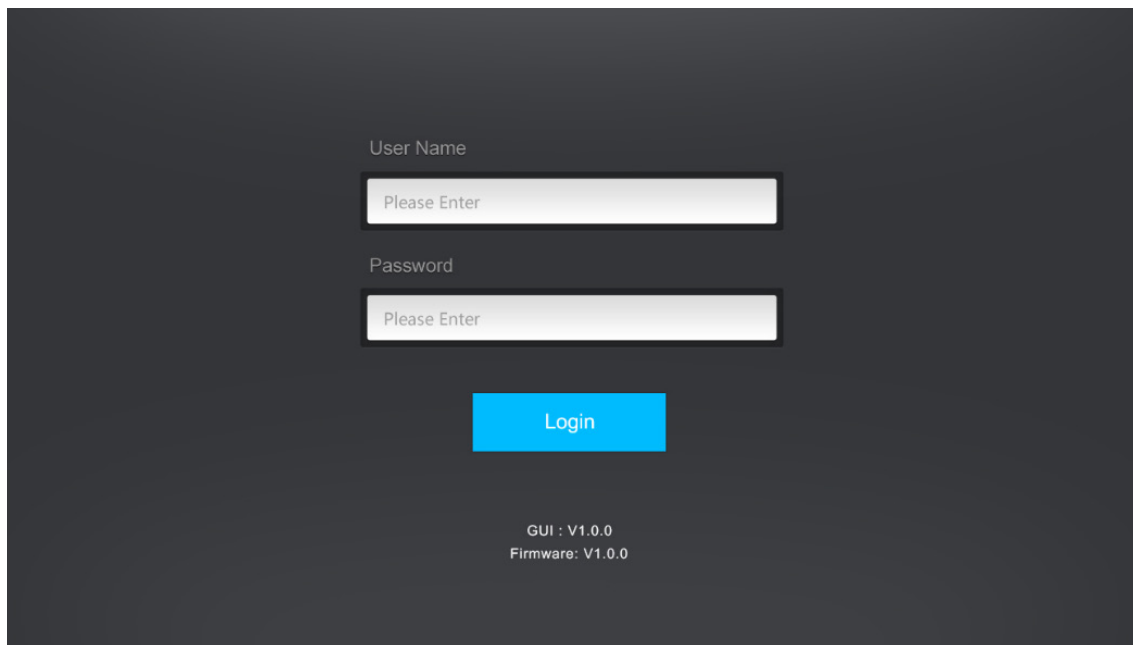

User Name
Please Enter

Password
Please Enter

Login

GUI : V1.0.0
Firmware: V1.0.0

A/V Switching

The *CONTROL* menu allows you to route A/V signals from the video inputs to the HDMI and HDBaseT outputs of the switcher and enable / disable auto switching mode.

To enable / disable auto switching mode, check the *ON/OFF* button in the *Auto Switching* menu. When auto switching is disabled, the switcher must be switched manually by either using the front panel buttons, the embedded web GUI or with the API. By default the DL-SCU41-TX is set to auto switching mode and follows the 'first in last out' method. To use *5V HDMI* or *A/V Signal Detection* for auto switching mode, check the desired button in the *Auto Switching* menu, the setting will take immediately. By default auto switching is set to 5V HDMI for the auto switching trigger.

When auto switching mode is disabled, the video route for either HDMI and HDBT outputs can be routed manually by checking the input buttons that corresponds with the output in the web GUI. *TX HDMI OUT* refers to the DL-SC41U-TX, *RX HDMI OUT* refers to the optional DL-SCU-RX HDBaseT receiver.

When auto switching mode is enabled, the selected AV input will be routed to both outputs except for the HDMI input on the optional DL-SCU-RX HDBaseT receiver which can only be routed to the HDBaseT receiver HDMI output.

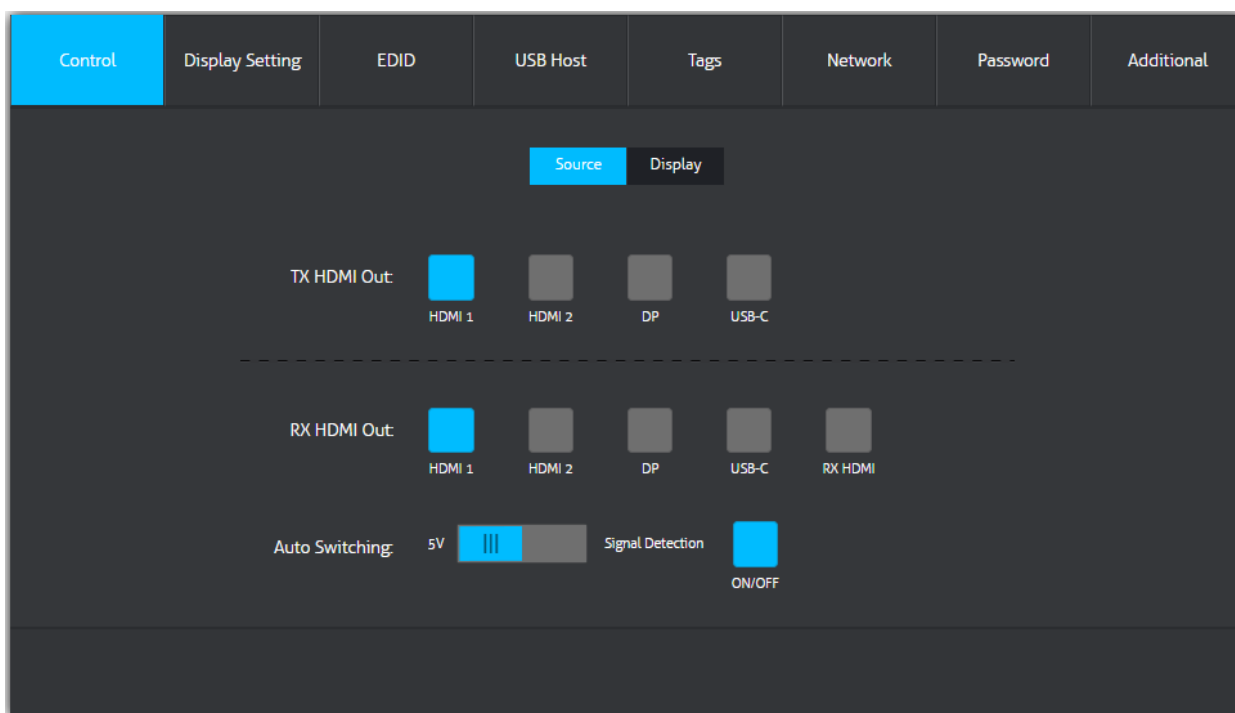

RS232 Display Control Settings

The *Display Setting > RS232* menu allows you to configure RS232 serial strings to be transmitted to a connected display to either the DL-SC41U-TX or the optional HDBaseT receiver. An RS232 / serial connection must be made from either device to a display for this option to work.

Refer to the projector or displays owners manual to obtain the RS232 / serial strings for control. You will want to locate the ON, OFF, INPUT, VOLUME UP and VOLUME DOWN string, what the default baud rating is for the serial connection on the display, what pins should be terminated for TX,RX and how the commands must be terminated i.e. carriage return, line feed etc. Be sure the TX, RX pins are appropriately connected from the display to the switcher. See page 8 for making a serial connection

Control	Display Setting	EDID	USB Host	Tags	Network	Password	Additional
				RS232	Additional		
Baud Rate:	9600			<input type="checkbox"/>	Hex		
Command Ending:	CR+LF			Display Off:	PWROFF	<input checked="" type="checkbox"/>	x2
Display On:	PWRON			Display Off x2 Delay:	1	s	
Input Delay:	10			Volume +:	VOL+		
Display Input Select:	INPU]			Volume -:	VOL-		
Trigger 'Display On' -> wait 'Delay' -> Send 'Display Input Select'							
Save							

Enter baud rate of the display under *BAUD RATE*

Enter the string terminator under *COMMAND ENDING*

- *NULL*- None
- *CR*- Carriage Return
- *LF*- Line Feed
- *CR + LF* - Carriage Return + Line Feed

Enter the display ON string in the *DISPLAY ON* field

Enter the desired time delay in seconds in the *INPUT DELAY* field for the input command. The input command will be transmitted to the display after the input command has been generated.

Enter the desired display input string in the *DISPLAY INPUT SELECT* field

Enter the display OFF string in the *DISPLAY OFF* field, check the X2 box if the command must be repeated 2 times then enter the display off delay in seconds in the *DISPLAY OFF X2 DELAY* field.

Enter the volume up and down strings in the *VOLUME +* and *VOLUME -* fields. Note that the volume commands will be used to turn up / down the volume of the line level output on the optional HDBaseT receiver.

Click *SAVE* to save settings

NOTE: The strings saved in this menu can be triggered manually with the DL-SC41U-TX front panel buttons.

Auto Display ON/OFF Settings

The *DISPLAY SETTING > ADDITIONAL* menu allows you to enable / disable automatic display ON/OFF control.

When display control is ON, the DL-SC41U-TX can turn the display or projector ON using the stored RS232 commands previously set up in the *DISPLAY SETTING > RS232* menu or by CEC when an AV signal is introduced to either of the switchers inputs. When an AV signal is not present after a specified time, the DL-SC41U-TX can generate the saved RS232 OFF command as well as CEC to turn OFF the display or projector.

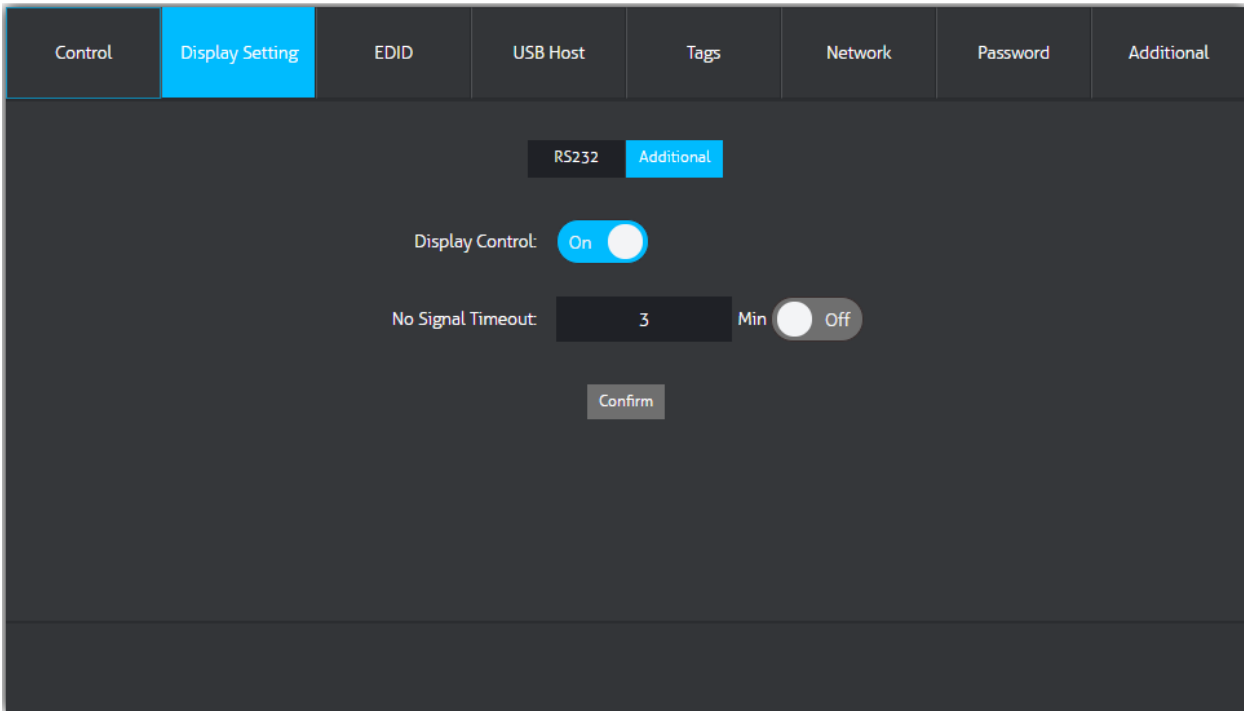

By default the *DISPLAY CONTROL* option is *ON*, press the ON toggle button to disable *DISPLAY CONTROL*

Enter in the time in minutes in the *NO SIGNAL TIMEOUT* form, press the ON/OFF timeout toggle to enable/disable automatic OFF control.

Press *CONFIRM* to save any settings

USB Host Switching Settings

In the DL-SC41U-TX there are three USB hosts that can be switched either automatically, manually or they can be set to follow the video input automatically when the AV input is selected. By default, PC 1 USB host follows HDMI 1, PC 2 USB host follows HDMI 2 and when connecting USB C device it also switches to this input as a host.

The screenshot shows the 'USB Host' settings menu. The menu is titled 'USB Host' and is highlighted in blue. It contains three radio button options: 'Auto Switch', 'Manual', and 'Follow Video'. The 'Follow Video' option is selected. Under 'Follow Video', there are two columns of settings. The first column has 'HDMI 1' with a dropdown menu set to 'PC 1' and 'DP' with a dropdown menu set to 'N/A'. The second column has 'HDMI 2' with a dropdown menu set to 'PC 2' and 'USB-C' with a dropdown menu set to 'USB-C'. A 'Confirm' button is located at the bottom center of the menu.

To change the USB hosts to switch automatically based on USB signal detection on either PC 1, PC 2 or USB C check the *AUTO SWITCH* option

To manually switch to the desired USB host check the *MANUAL* option and then choose which host to switch to PC1 or PC2.

To set a USB host to follow a selected video input, select *FOLLOW VIDEO* and use the drop down buttons to assign hosts to inputs. USB-C will always switch as the host when this input is selected

Press *CONFIRM* to save any settings

Edid Management

EDID can be set for each A/V input using the *EDID* menu.

To adjust an inputs EDID option, click on the desired input channel then click on the desired resolution, then click *CONFIRM*.

When uploading a *USER DEFINED* EDID option, click the open field to locate the .bin EDID file on your local computer, then click *APPLY*.

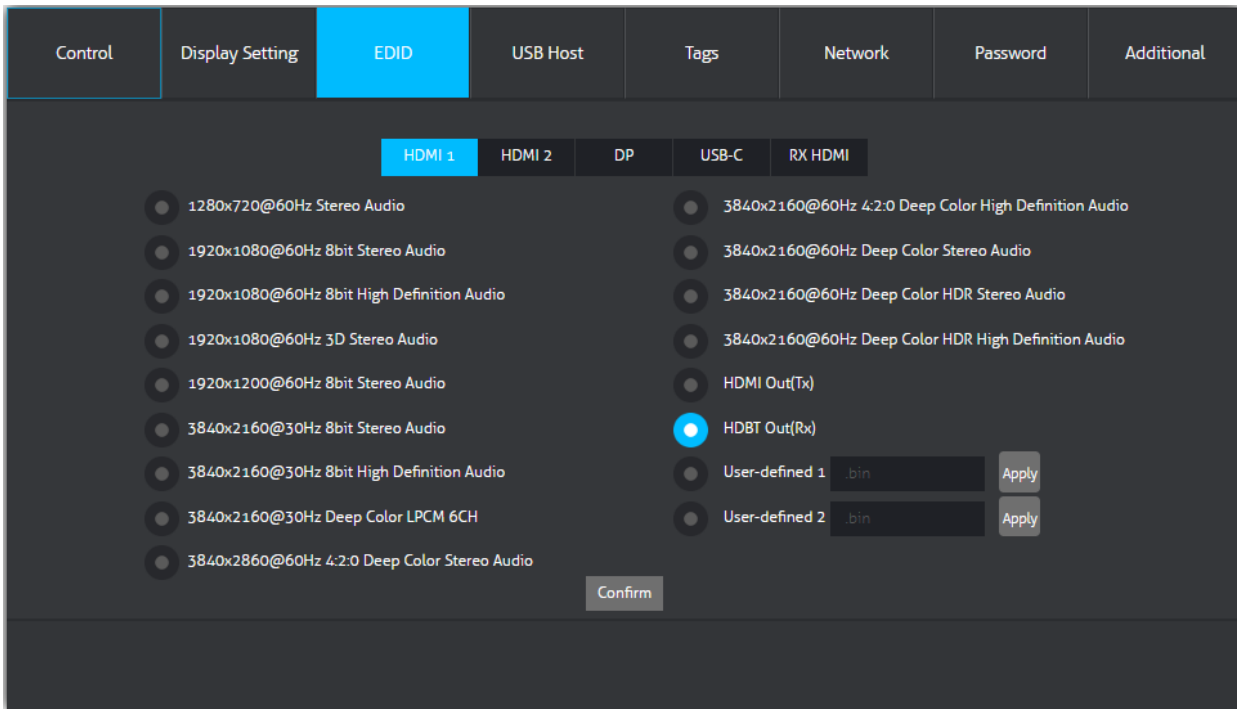

In the event EDID fails the DL-SC41U-TX will default to 1080p for all inputs.

Relay Configuration

Latching or momentary relay modes can be set using the *CONTROL* > *DISPLAY* menu.

To adjust RELAY 1 or RELAY 2, navigate to the *CONFIGURATION* menu, then click on the *RELAY* option. Choose either *MOMENTARY* or *LATCHING* mode for each relay. When choosing the *MOMENTARY* option, define how long the relay will stay open/closed.

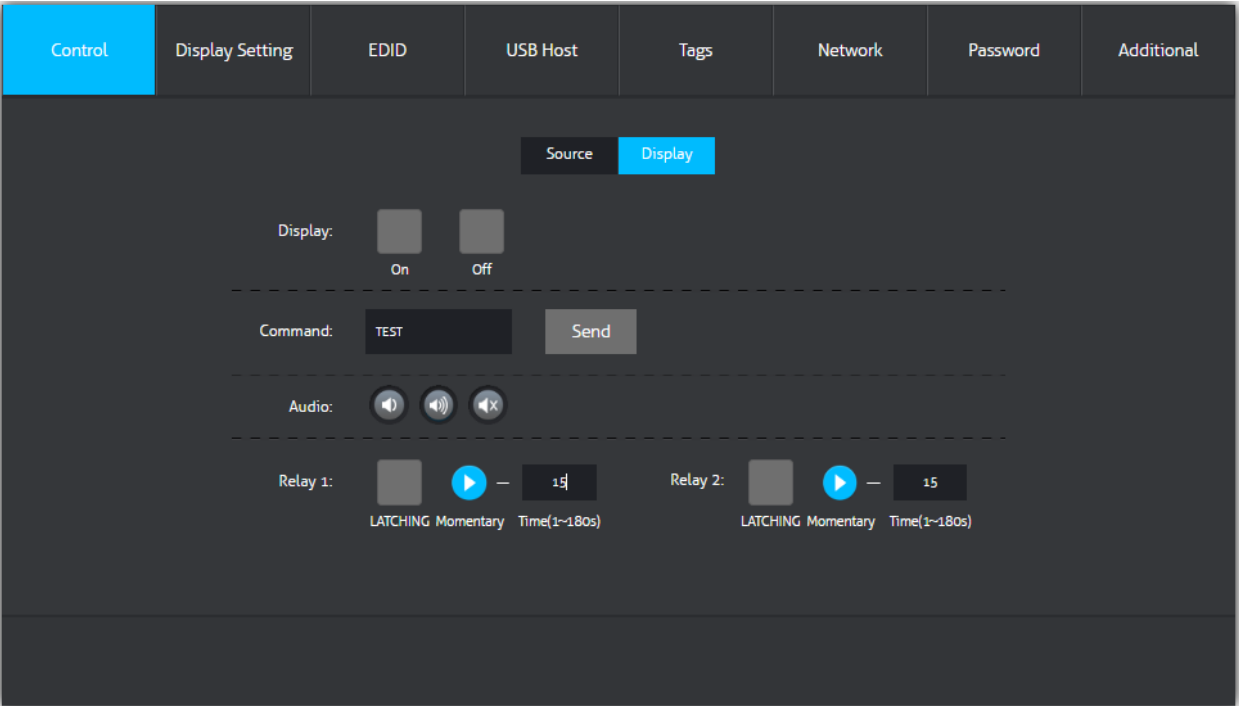

Renaming Inputs

The *Tags* menu allows you to set user defined names for inputs and presets that will be displayed on the VIDEO tab for easy system control

Navigate to the *Tags* menu, enter in the desired names for the *INPUTS* and *PRESET* sections, then click *CONFIRM*.

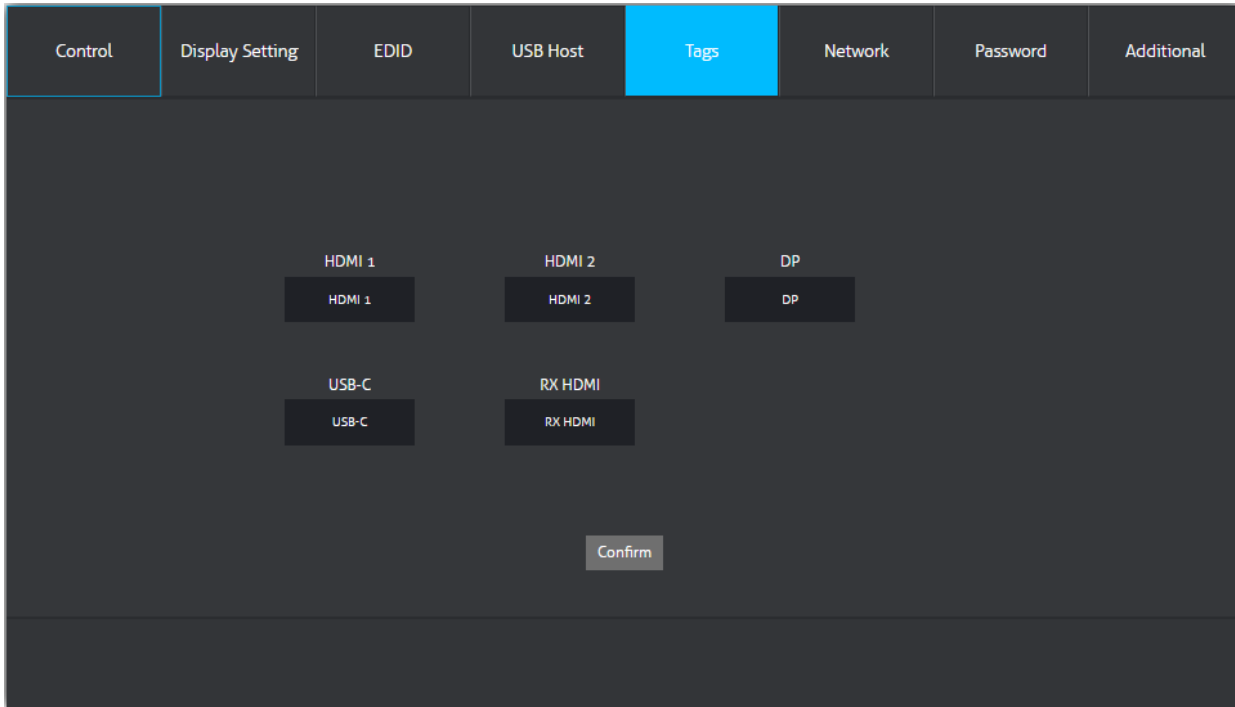

Network Settings

The *Network* menu allows you to set the network settings for the device.

Navigate to the *Network* menu, select either *DHCP* or *STATIC IP* as the desired IP mode. If choosing *DHCP*, make sure the DL-SC41U-TX is connected to a router / network switch with DHCP server support. When choosing the *STATIC IP* option, manually enter in the desired *IP ADDRESS*, *SUBNET MASK* and *GATEWAY* information, then click *CONFIRM* for changes to take place. Depending on the newly given IP address range you may need to adjust your computers IP address settings to log back into the web GUI server for the DL-SC41U-TX i

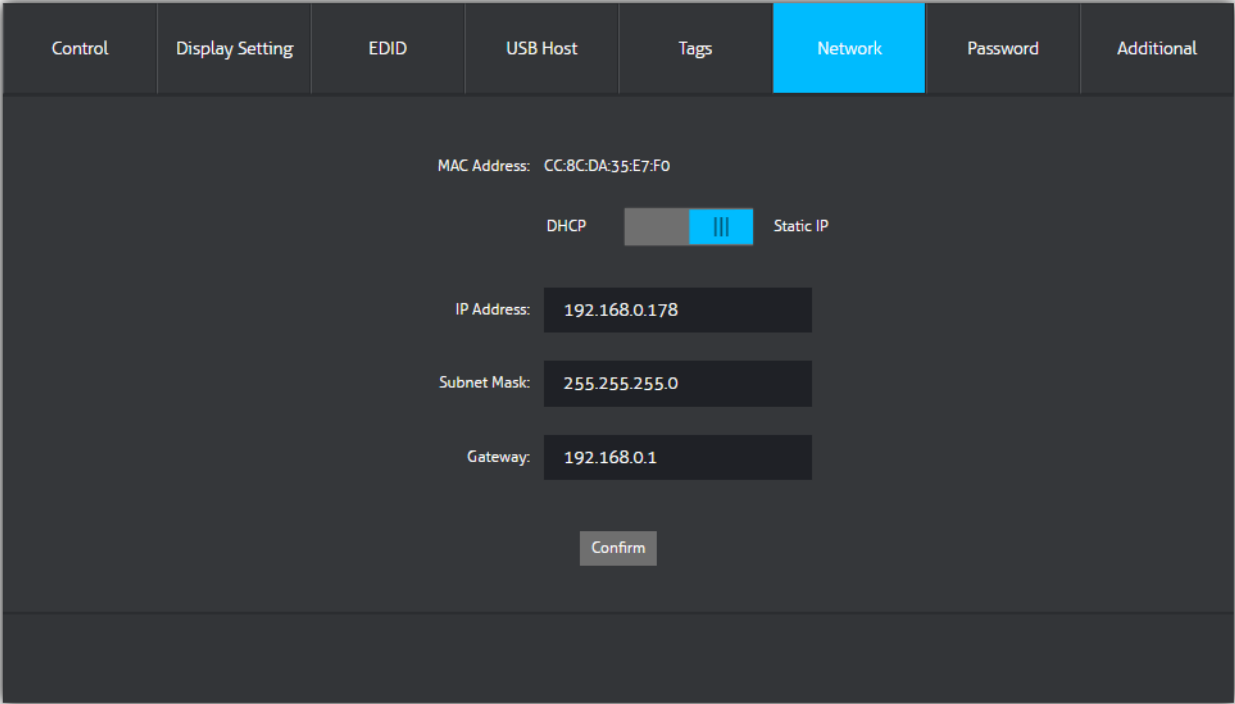

Security Settings

The *PASSWORD* menu allows you to set the admin password to a user defined password

Navigate to the *PASSWORD* menu, enter in a user defined password in the password field, then click *CONFIRM*.

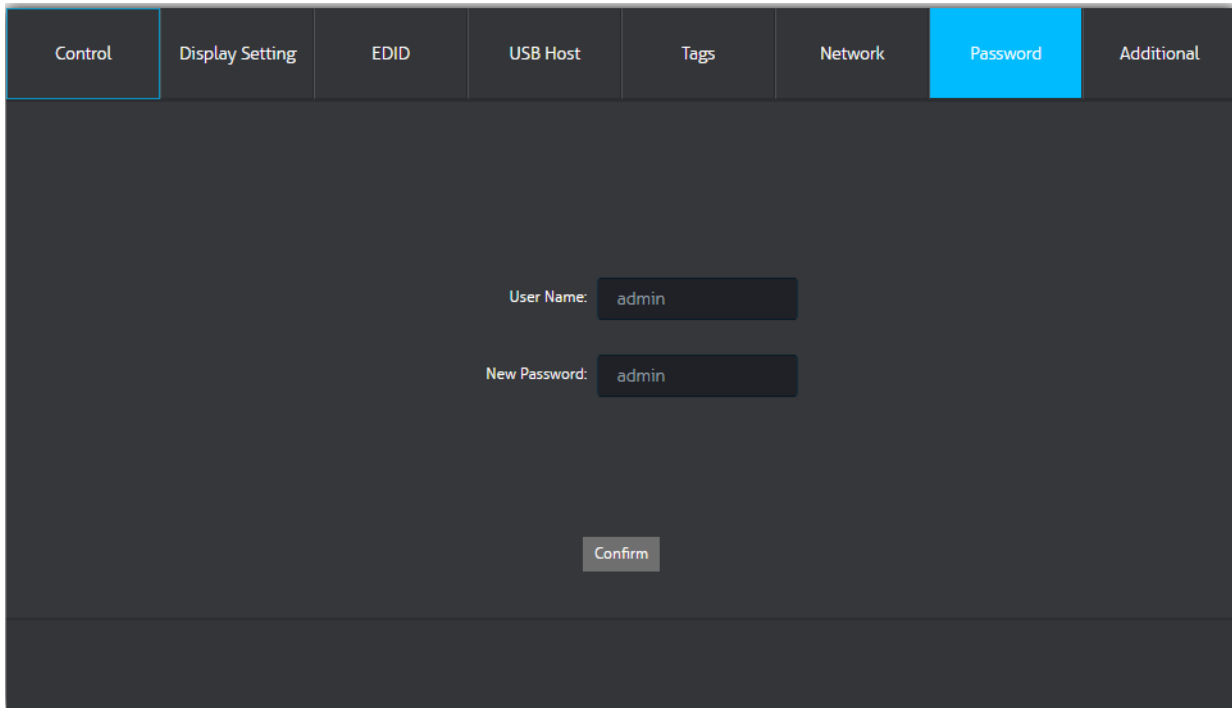

The screenshot shows a web interface with a dark grey background. At the top, there is a horizontal menu with eight items: Control, Display Setting, EDID, USB Host, Tags, Network, Password, and Additional. The 'Password' item is highlighted in a bright blue color. Below the menu, the main content area contains two text input fields. The first field is labeled 'User Name:' and contains the text 'admin'. The second field is labeled 'New Password:' and also contains the text 'admin'. Below these fields, there is a grey button labeled 'Confirm'.

System Settings

The *ADDITIONAL* menu allows you to change the baud rate of the DL-SC41U-TX switcher, factory default the unit or turn the POWER OFF to the switcher

Choose or change an option then click *CONFIRM*.

Control	Display Setting	EDID	USB Host	Tags	Network	Password	Additional
Device Baud Rate: 9600							

Factory Default: <input type="checkbox"/>							

Power Off: <input type="checkbox"/>							
Confirm							

RS232 and TCP/IP Control

RS232 Settings: 9600 baud, 8 Data bits, 1 Stop bit, Parity = None

Telnet Settings: User defined IP address (default IP address:192.168.0.178), port 4001

The commands are case sensitive and must be terminated with a carriage return <CR> and line feed <LF>

A/V Routing

Description	Command	Examples
Set output switching mode to manual switching or to auto switching NOTE: When using the manual switching commands in this API the switching mode status should be set to MANUAL	<pre>#SET_AUTO_SWITCH {O} {M}</pre> <p>{O} = HDMI, HDBT {M} = 0 (MANUAL) 1 (AUTO)</p>	<pre>Command: #SET_AUTO_SWITCH HDMI 1 Response: @HDMI_AUTO_SWITCH 1</pre>
Query switching mode status	<pre>#GET_AUTO_SWITCH</pre>	<pre>Command: #GET_AUTO_SWITCH Response: @HDMI_AUTO_SWITCH 1</pre>
Routing inputs to outputs	<pre>#SET_AV {O} {I}</pre> <p>{O} = HDMI, HDBT {I} = H1 (HDMI 1) H2 (HDMI 2) DP (DISPLAYPORT) C (USB-C) RXH (RX HDMI)</p> <p>NOTE: When using RXH parameter this can only be used when the optional DL-SCU-RX is used with the DL-SC41U-TX</p>	<pre>Command: #SET_AV HDMI H1 Response: @HDMI_AV H1</pre>
Query routing status	<pre>#GET_AV</pre>	<pre>Command: #GET_AV Response: @HDBT_AV H1 @HDMI_AV H2</pre>

USB Host Routing

Description	Command	Examples
Set USB switching mode to manual switching or to auto switching or to follow video inputs NOTE: When using the manual switching commands in this API the switching mode status should be set to MANUAL	<pre>#SET_USB_SWITCH_MODE {m} {m} = 0 (AUTO) 1 (MANUAL) 2 (FOLLOW VIDEO)</pre>	<pre>Command: #SET_USB_SWITCH_MODE 0 Response: @USB_SWITCH_MODE 0</pre>
Query switching mode status	<pre>#GET_USB_SWITCH_MODE</pre>	<pre>Command: #GET_USB_SWITCH_MODE Response: @USB_SWITCH_MODE 0</pre>
Switching / selecting USB Host	<pre>#SET_USB_MANUAL {H} {H} = PC1 PC2 USBC</pre>	<pre>Command: #SET_USB_MANUAL PC1 Response: @USB_CH PC1</pre>
Query selected USB Host	<pre>#GET_USB_SWITCH</pre>	<pre>Command: #GET_USB_SWITCH Response: @USB_CH PC1</pre>

CEC / RS232 Display Control

Description	Command	Examples
Send TV ON/OFF display commands using CEC (HDMI) or RS232 NOTE: The RS232 commands can be configured and stored in the web GUI, see page 15	<pre>#SET_DISPLAY {O} {S}</pre> <p>{O} = HDMI, HDBT {S} = ON, OFF</p>	<pre>Command: #SET_DISPLAY HDMI ON Response: @SET_HDMI_DISPLAY ON</pre>
Send TV volume up/down and mute display commands using CEC (HDMI) or RS232 NOTE: The RS232 commands can be configured and stored in the web GUI, see page 15	<pre>#SET_VOL {O} {V}</pre> <p>{O} = HDMI, HDBT {V} = + (UP) = - (DOWN) = MUTE</p>	<pre>Command: #SET_VOL HDMI + Response: @HDMI_VOL +</pre>

Relay Control

Description	Command	Examples
Opens, closes relays NOTE: Relay commands this can only be used when the optional DL-SCU-RX is used with the DL-SC41U-TX	<pre>#SET_RELAY_CONTROL_MODE {R} {S}</pre> <p>{R} = RELAY1, RELAY2 {S} = 1 (CLOSE) 0 (OPEN)</p>	<pre>Command: #SET_RELAY_CONTROL_MODE RELAY1 0 Response: @RELAY1_CONTROL_MODE 0</pre>
Sets momentary time in seconds	<pre>#SET_RELAY_AUTO_TIME {R} {T}</pre> <p>{R} = RELAY1, RELAY2 {T} = 1-180 (SECONDS)</p>	<pre>Command: #SET_RELAY_AUTO_TIME RELAY1 5 Response: @RELAY1_AUTO_TIME 5 SECONDS</pre>
Query relay status	<pre>#GET_RELAY_AUTO_TIME</pre>	<pre>Command: #GET_RELAY_AUTO_TIME Response: @RELAY1_AUTO_TIME 10 SECONDS @RELAY2_AUTO_TIME 10 SECONDS</pre>

System Commands

Description	Command	Examples
Set switcher in standby mode	<pre>#SET_POWER {M} {M} = 0 (STANDBY) 1 (ON)</pre>	<pre>Command: #SET_POWER 0 Response: @POWER 0</pre>
Query standby status	<pre>#GET_POWER</pre>	<pre>Command: #GET_RELAY_AUTO_TIME Response: @POWER 0</pre>
Set baud rate of switcher	<pre>#SET_RS232_BAUD {B} {B} = 0 (115200) 1 (57600) 2 (38400) 3 (19200) 4 (9600) 5 (4800) 6 (2400)</pre>	<pre>Command: #SET_RS232_BAUD 4 Response: @RS232_BAUD 4</pre>
Query current baud rate	<pre>#GET_RS232_BAUD</pre>	<pre>Command: #GET_RS232_BAUD Response: @RS232_BAUD 4</pre>
Front panel button lock	<pre>#SET_KEYPAD_LOCK {K} {K} = 0 (UNLOCK) 1 (LOCK)</pre>	<pre>Command: #SET_KEYPAD_LOCK 0 Response: @KEYPAD_LOCK 0</pre>
Query button lock status	<pre>#GET_KEYPAD_LOCK</pre>	<pre>Command: #GET_KEYPAD_LOCK Response: @KEYPAD_LOCK 0</pre>
Reboot	<pre>#REBOOT</pre>	<pre>Command: #REBOOT Response: @REBOOT</pre>
Factory Reset	<pre>#FACTORY RESET</pre>	<pre>Command: #FACTORY RESET Response: @FACTORY RESET</pre>

Technical Specifications

Video	
Video Inputs	(2) HDMI, (1) Display Port, (1) USB-C
Video Input Connector	(2) HDMI type A, (1) Display Port, (1) USB-C
Input Video Signal	HDMI for HDMI input, DisplayPort 1.2 for Display Port, ALT-DP Mode for USB-C
Video Output	(1) HDMI, (1) HDBaseT
Video Output Connector	(1) HDMI type A, (1) RJ45
Input Resolution Support	HDMI / Display Port: Up to 3840 x 2160 @60Hz / 4:4:4 / 8 bit deep color USB-C: Up to 3840 x 2160 @30Hz / 4:4:4 / 8 bit deep color
Output Resolution Support	HDMI: Up to 4K@60Hz 4:4:4 HDBaseT: Up to 4K@60Hz 4:2:0
Standards	Compliant with HDMI 2.0b, HDCP 2.2 and CEC
Bandwidth	All Inputs: 18Gbps HDMI Output: 18Gbps HDBaseT Output: 10.2Gbps
HDBaseT 2.0 Transmission Distance	1080P @ 70m or less when using Cat6 F/UTP, 4K @ 40m or less when using Cat6 F/UTP
USB	
Supported USB Standard	Local Switcher: Up to USB 3.0 @ 5Gbps HDBaseT 2.0 Receiver (optional): Up to USB 2.0 High Speed up to 190Mbps
USB Port Types	(2) USB B (Host) (1) USB C (Host) (2) USB A (Client)
Audio	
Supported output formats	HDMI Embedded: LPCM 7.1 audio, Dolby Atmos®, Dolby® TrueHD, Dolby Digital® Plus, DTS: X™, and DTS-HD® Master Audio™ pass-through
Device Control Parameters	
Ethernet	100BaseT
RS232 Baud Rate	9600 baud (default)
Chassis and Environmental	
Dimensions (WxHxD)	220 mm x 44 mm x 130 mm (8.7 in x 1.7 in x 5.1 in)
Shipping Weight	605g (1.3lbs.)
Operating Temperature	0° to +55° C (+32° to +131° F)
Operating Humidity	10% to 90%, Non-condensing
Storage Temperature	-20° to +70° C (+14° to +158° F)
Storage Humidity	10% to 90%, Non-condensing
Power, ESD, and Regulatory	
Power Supply Input	100V-240VAC / 50-60 Hz
Power Supply Output	24VDC / 5A
Power Consumption	32 watts (68 watts MAX with USB-C power charging support)
USB-C Power Consumption	40 watts
ESD Protection	15kV
Product Regulatory	FCC, CE, RoHS
Power Supply Regulatory	CE, RoHS
Other	
Standard Warranty	5 years
Included Accessories	Quick Install Guide, Power Supply with US, UK, AU and EU power plugs, (1) 3-pin to DB9 RS232 Cable, (2) Mounting clips with screws and (4) plastic cushions

Thank you for your purchase.

For Technical Support please call our toll
free number at 800-530-8998 or email us at
supportlibav@libav.com

www.libav.com

Digitalinx is a brand of:

